



ACOUSTIC CHARACTERISTICS

L_w can be obtained by summing the values from the table below to the value from the chart.

Type	63	125	250	500	1000	2000	4000	8000
80	10	16	12	9	5	-1	-6	-23
100	9	16	11	7	3	-1	-9	-22
125	12	15	9	7	3	-4	-15	-20
160	12	13	6	4	0	-1	-5	-17
200	12	11	6	2	-1	-1	-6	-18
250	15	12	5	3	1	-3	-12	-17
315	15	10	5	0	-1	-1	-12	-23
400	15	9	6	2	-1	-4	-9	-13
500	14	7	4	1	-1	-4	-8	-11
630	15	7	3	2	-1	-5	-9	-11
800	9	5	3	3	-1	-6	-10	-13
Tot	6	3	2	2	2	2	2	3

Flow setting:

In order to set the desired flow rate, use the read out of the housing K factor and the following relationship:

$$q = K \sqrt{\Delta_{pm}}$$

$$\Delta_{pm} = (q/K)^2$$

$$K = q / \sqrt{\Delta_{pm}}$$

q - airflow in l/s

Δ_{pm} - measured pressure in Pa

K - coefficient from the housing

Example:

For IRIS-125 at opening position 1 we can read from the housing the coefficient = 13,8.

If we measured for example 100 Pa - airflow we can calculate from the formula:

$$Q = K \times \sqrt{\Delta_{pm}} = 13,8 \times 10 = 138 \text{ l/s (496,8 m}^3\text{/h)}$$

APPLICATION

IRIS type damper is designed for circular ventilation ducts and provides easy control of air flow through the smooth change of the diameter of the flange.

CONSTRUCTION

The IRIS damper can be used in both exhaust and supply lines. It is equipped with lever for adjusting the hole diameter and two terminals for connection of flow control. The adjusting lever has two screws that block the desired throttle setting. The IRIS damper is made of galvanized steel and has two rubber seals for tight fitting in the duct.

INSTALLATION

Dampers should be mounted in the duct, providing straight sections:

- 4 x diameter of the duct before the throttle
- 1 x diameter of the duct behind the throttle

DIMENSIONS [mm]

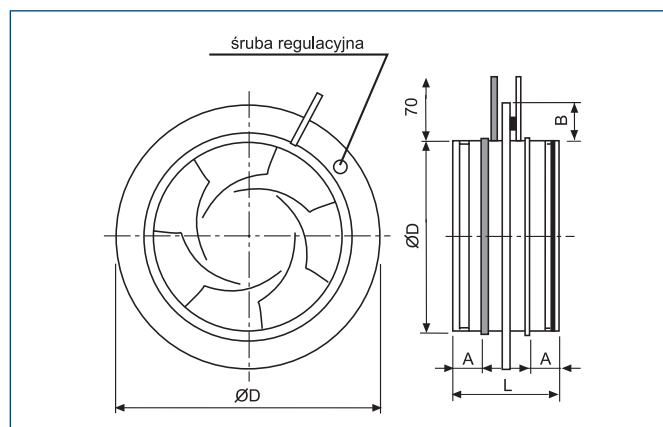

Type	Ød	ØD	L	A	B	weight [kg]	article number
80	79	125	110	30	22	0,5	19527080
100	99	165	110	30	32	0,6	19527100
125	124	210	110	30	42	0,9	19527125
160	159	230	110	30	35	1,1	19527160
200	199	285	110	30	42	1,6	19527200
250	249	335	135	40	42	2,1	19527250
315	314	410	135	40	47	3,5	19527315
400	398	525	190	60	62	6,4	19527400
500	498	655	170	50	77	9,6	19527500
630	628	815	170	50	92	15,6	19527630
800	798	1015	270	100	107	25	19527800

PERFORMANCE CURVES

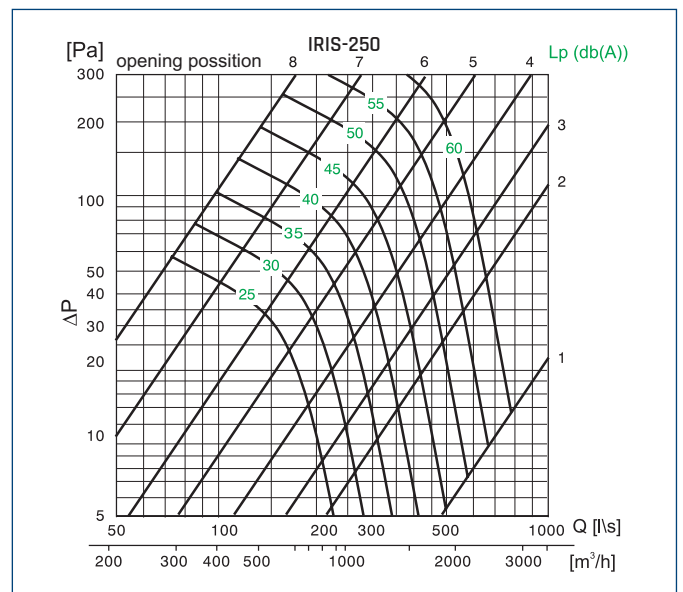
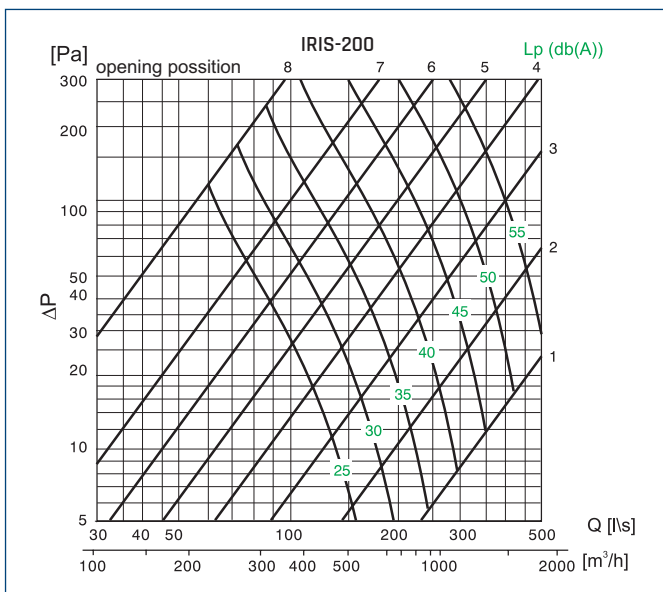
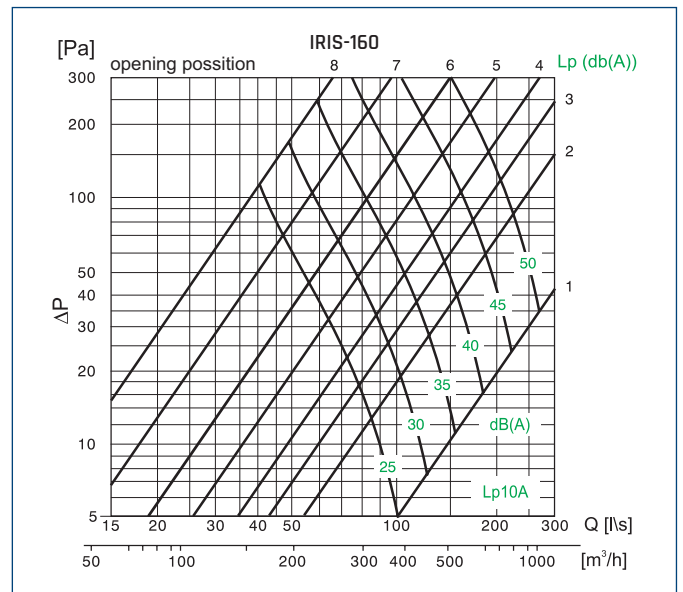
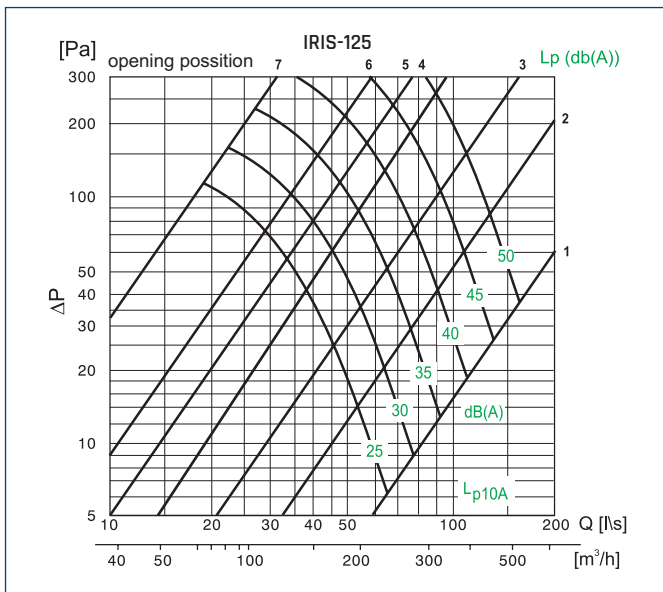
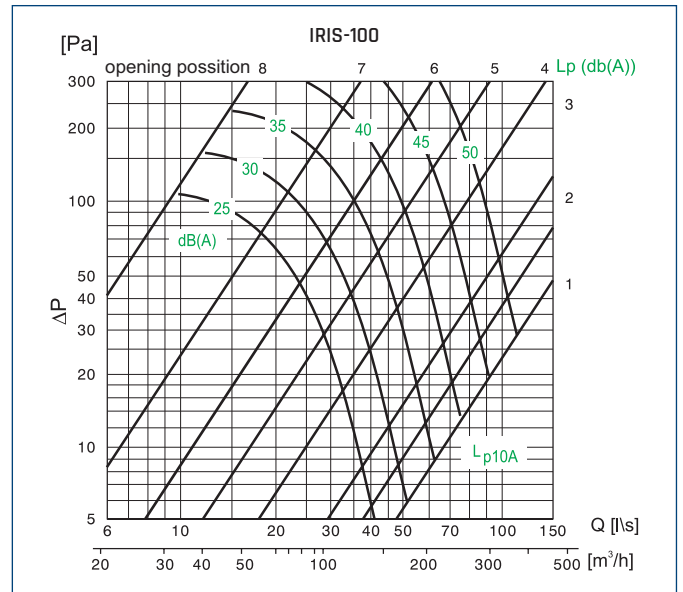
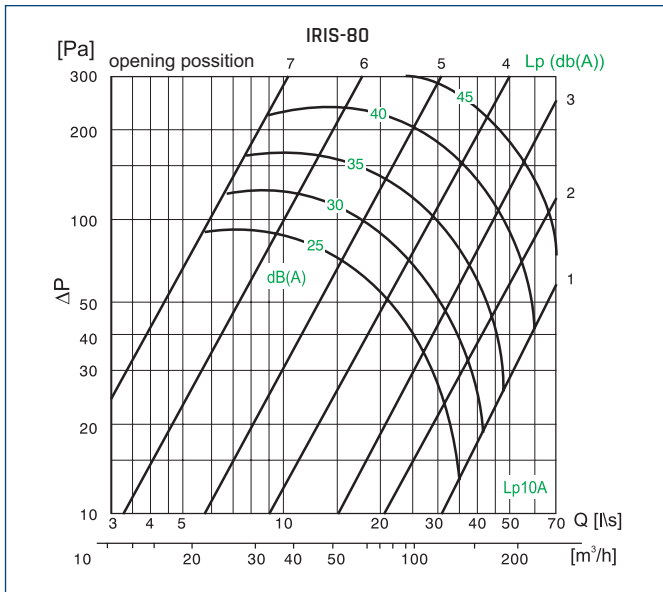

PERFORMANCE CURVES

