



ZASTOSOWANIE

Wentylator przeznaczony do transportu medium niezapalnego, zawierające-
go agresywne związki chemiczne. Typowe obszary zastosowania:

- dygestoria i laboratoria chemiczne
- przemysł chemiczny, farmaceutyczny, spożywczy
- obiekty użyteczności publicznej

KONSTRUKCJA

- wirnik z polipropylenu
- obudowa z tworzywa sztucznego wzmocnianego włóknem szklanym
- rozłącznik serwisowy na obudowie
- maksymalna temperatura tłoczonego medium 60°C
- temperatura otoczenia silnika od -20°C do +40°C

SILNIK ELEKTRYCZNY

- asynchroniczny, trójfazowy, 230/400 V, 50 Hz
- po za strumieniem zanieczyszczonego powietrza
- silnik przystosowany do regulacji częstotliwościowej.

DANE TECHNICZNE

Typ	wydajność max	ciśnienie max	moc silnika	prędkość obrotowa	napięcie	masa
	[m ³ /h]	[Pa]	[kW]	[obr/min]	[V]	[kg]
CDVA 400/30/1400	2600	220	0,18	1400	230/400	23
CDVA 400/30/900	1660	85	0,09	900	230/400	22
CDVA 400/35/1400	2920	225	0,25	1400	230/400	25
CDVA 400/35/900	1880	95	0,09	900	230/400	22
CDVA 400/45/1400	3300	200	0,55	1400	230/400	31
CDVA 400/45/900	2150	85	0,12	900	230/400	24
CDVA 450/30/1400	3800	270	0,55	1400	230/400	33
CDVA 450/30/900	2400	115	0,12	900	230/400	26
CDVA 450/35/1400	4100	280	0,55	1400	230/400	33
CDVA 450/35/900	2650	120	0,18	900	230/400	28
CDVA 450/45/1400	5050	260	1,1	1400	230/400	39
CDVA 450/45/900	3200	110	0,25	900	230/400	30
CDVA 500/30/1400	5350	280	0,55	1400	230/400	39
CDVA 500/30/900	3400	115	0,18	900	230/400	34
CDVA 500/35/1400	5650	290	0,75	1400	230/400	39
CDVA 500/35/900	3600	120	0,18	900	230/400	34
CDVA 500/45/1400	6400	315	1,1	1400	230/400	45
CDVA 500/45/900	4100	130	0,37	900	230/400	37
CDVA 560/30/1400	6650	325	0,75	1400	230/400	42
CDVA 560/30/900	4200	135	0,25	900	230/400	38
CDVA 560/35/1400	7800	285	1,1	1400	230/400	47
CDVA 560/35/900	4900	125	0,25	900	230/400	38
CDVA 560/45/1400	9400	330	1,5	1400	230/400	49
CDVA 560/45/900	5900	140	0,55	900	230/400	41
CDVA 630/30/1400	9800	350	1,5	1400	230/400	53
CDVA 630/30/900	6200	140	0,55	900	230/400	45
CDVA 630/35/1400	10800	340	2,2	1400	230/400	63
CDVA 630/35/900	6850	140	0,55	900	230/400	45
CDVA 630/45/1400	11450	355	4	1400	230/400	71
CDVA 630/45/900	7150	150	1,1	900	230/400	53
CDVA 710/30/1400	13000	440	4	1400	230/400	68
CDVA 710/30/900	7900	180	0,75	900	230/400	55
CDVA 710/35/1400	14400	510	3	1400	230/400	70
CDVA 710/35/900	9000	210	0,75	900	230/400	55
CDVA 710/45/1400	16250	530	5,5	1400	230/400	100
CDVA 710/45/900	10150	230	1,5	900	230/400	64

* pomiar w odległości 1m od wentylatora.

CHARAKTERYSTYKI PRACY I CHARAKTERYSTYKA AKUSTYCZNA

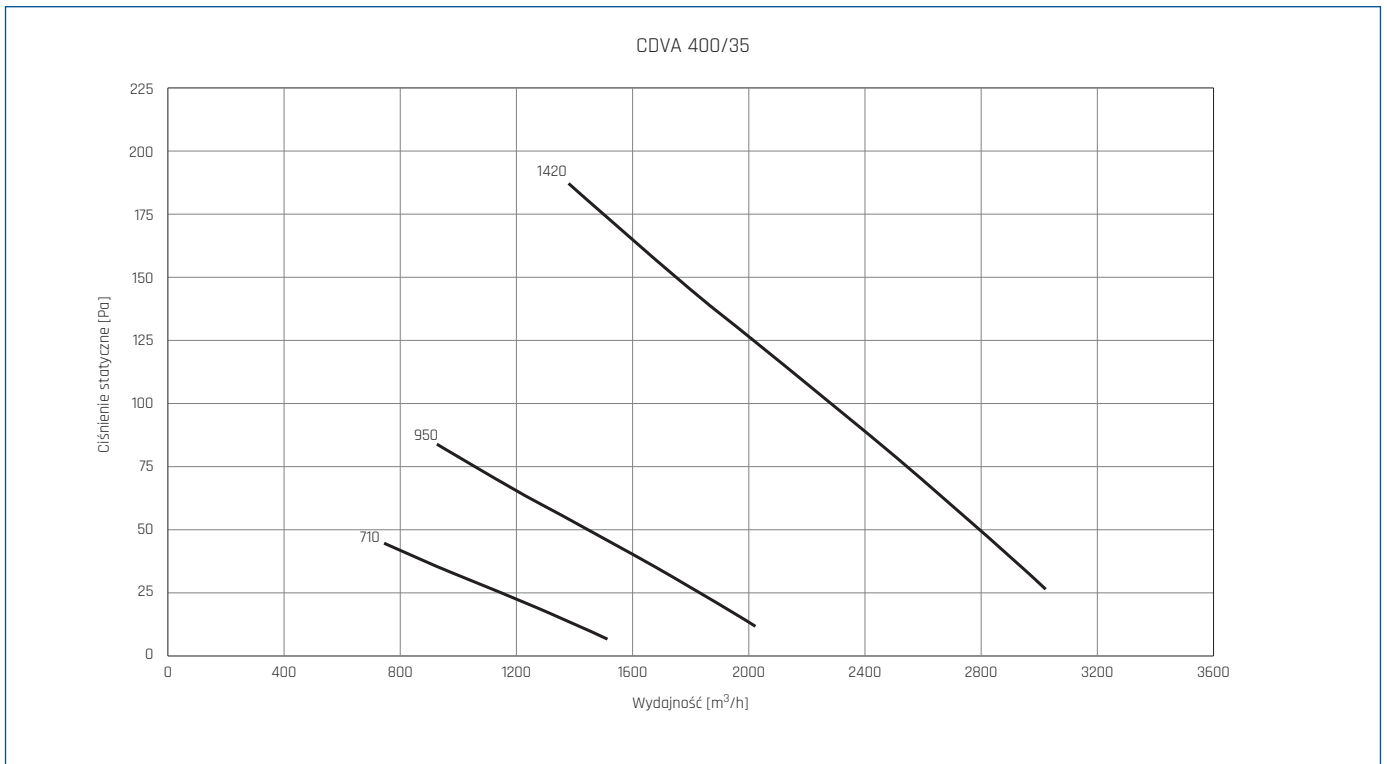
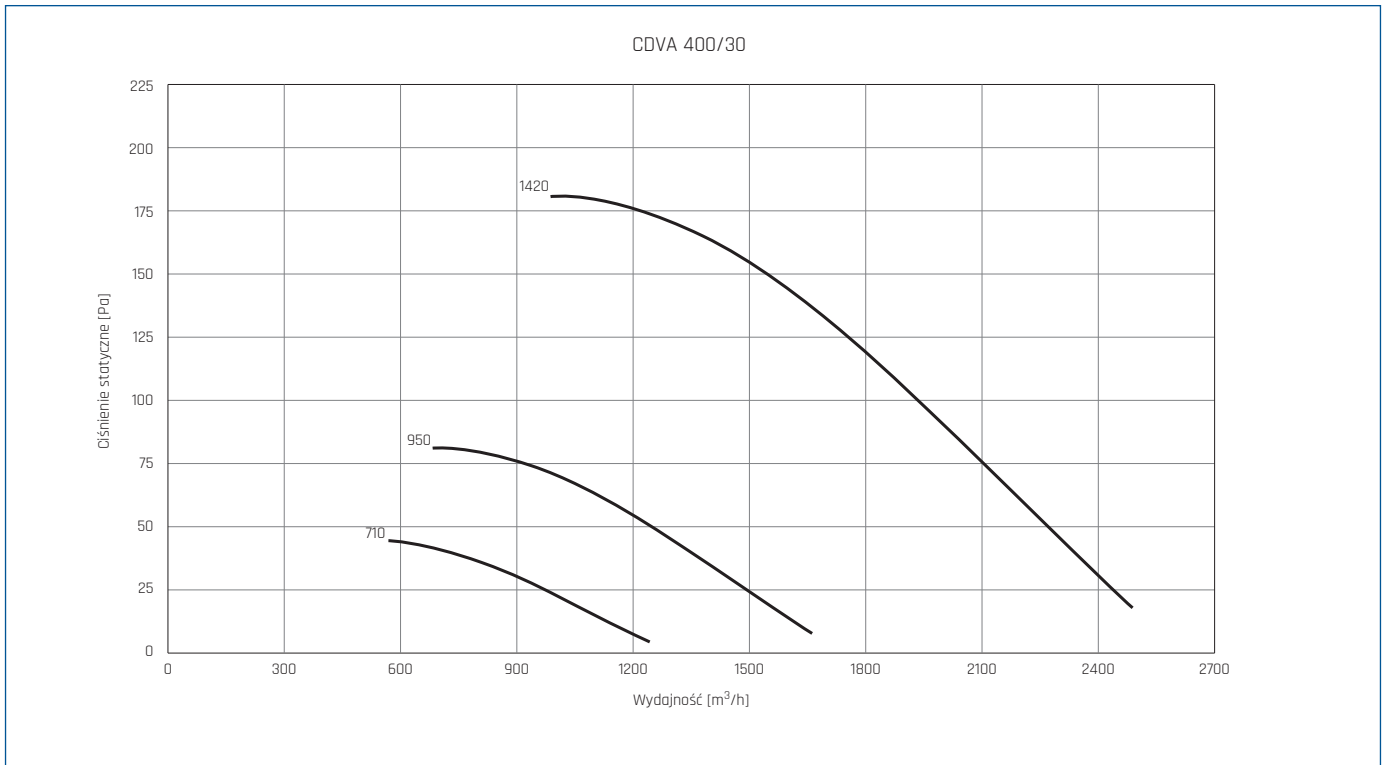

CDVA 400/30

n [obr/min]	L _{WA} [dB(A)]	Hz							
		63	125	250	500	1000	2000	4000	8000
700	58	36	45	52	53	52	50	46	42
900	64	42	51	58	59	58	56	52	48
1400	73	51	60	67	68	67	65	61	57

CDVA 400/35

n [obr/min]	L _{WA} [dB(A)]	Hz							
		63	125	250	500	1000	2000	4000	8000
700	60	37	46	53	55	53	51	47	43
900	66	43	52	59	61	59	57	53	49
1400	75	52	61	68	70	68	66	62	58

Poziom mocy akustycznej L_{WA} [dB(A)], Poziom ciśnienia akustycznego L_{PA} = L_{WA} - 7 dB(A), Odległość 1m.

CHARAKTERYSTYKI PRACY I CHARAKTERYSTYKA AKUSTYCZNA

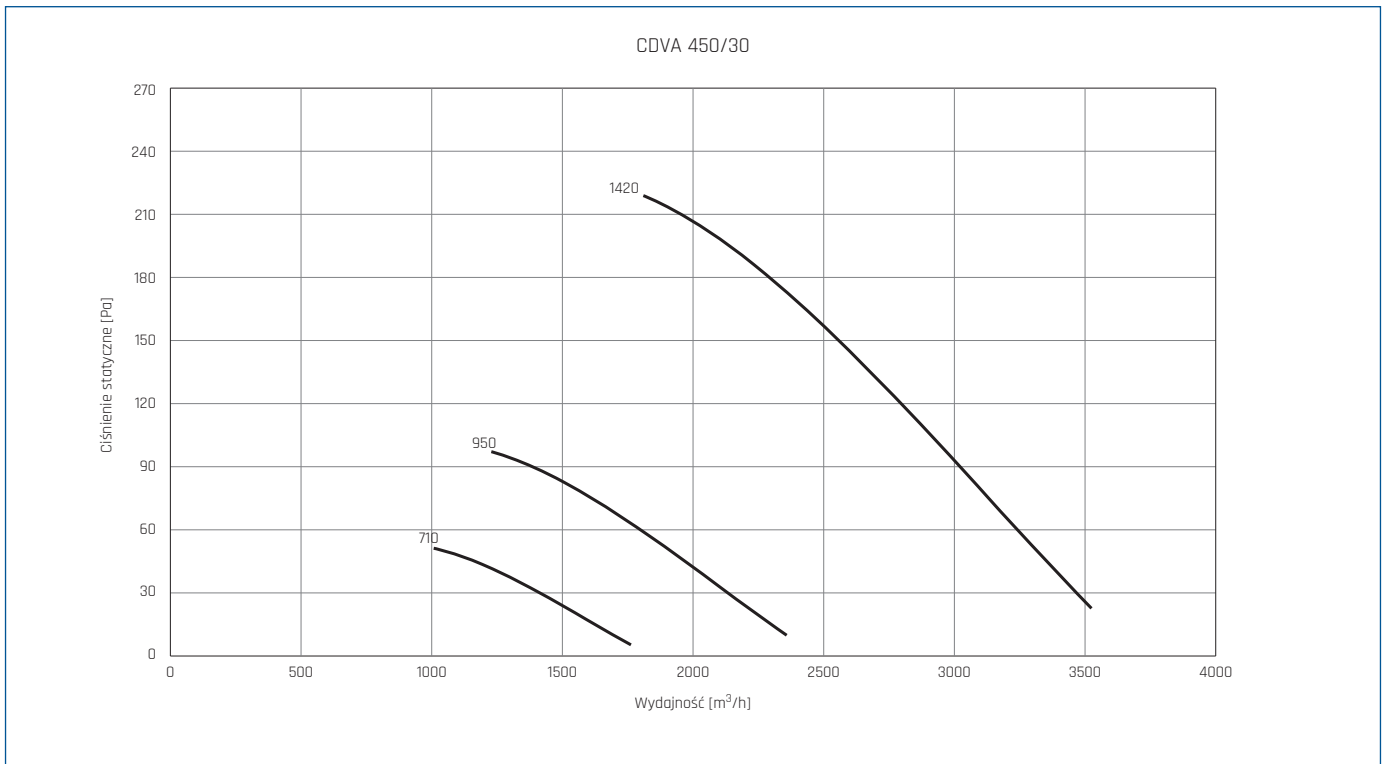
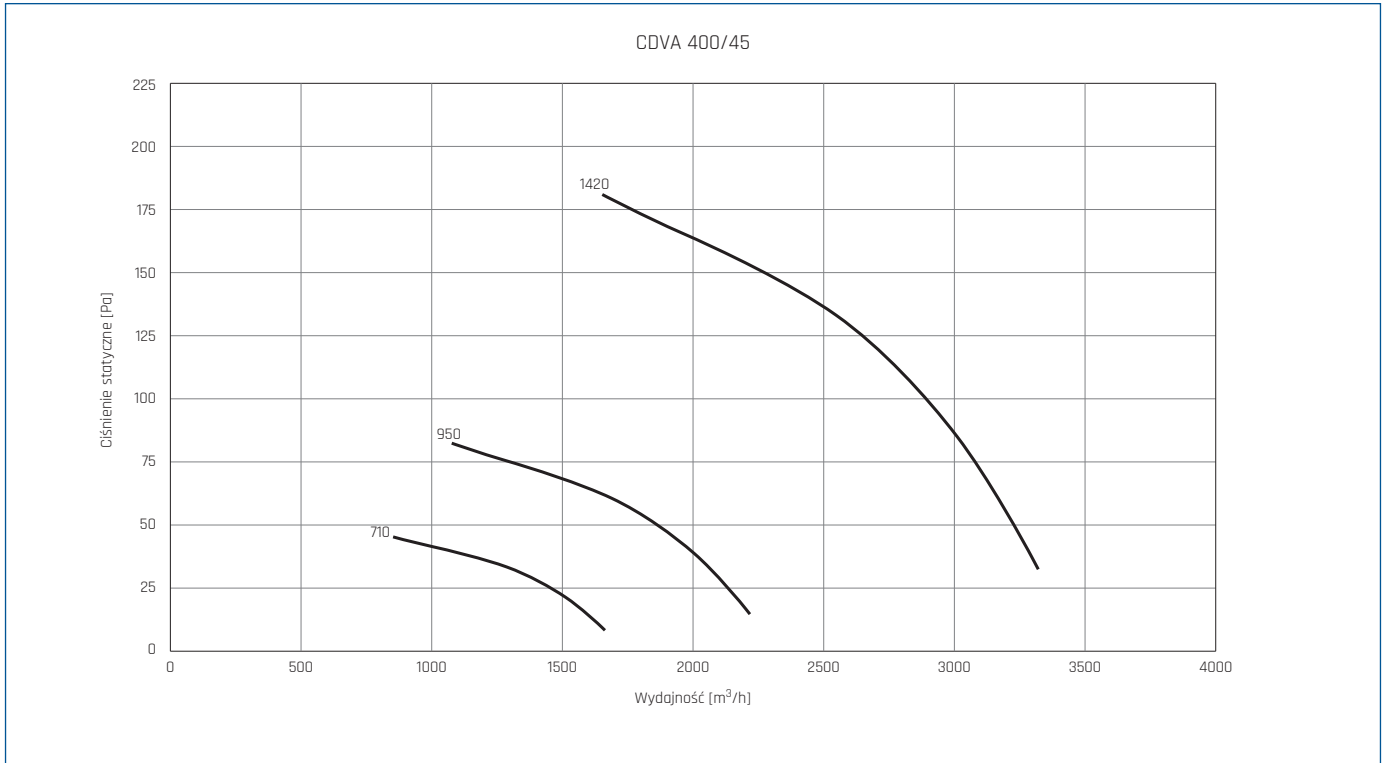

CDVA 400/45

n [obr/min]	L _{WA} [dB(A)]	Hz							
		63	125	250	500	1000	2000	4000	8000
700	61	38	48	54	56	54	52	48	44
900	67	44	54	60	62	60	58	54	50
1400	76	53	63	69	71	69	67	63	59

CDVA 450/30

n [obr/min]	L _{WA} [dB(A)]	Hz							
		63	125	250	500	1000	2000	4000	8000
700	63	41	50	57	58	57	55	51	47
900	69	47	56	63	64	63	61	57	53
1400	78	56	65	72	73	72	70	66	62

Poziom mocy akustycznej L_{WA} [dB(A)], Poziom ciśnienia akustycznego L_{PA} = L_{WA} -7 dB(A), Odległość 1m.

CHARAKTERYSTYKI PRACY I CHARAKTERYSTYKA AKUSTYCZNA

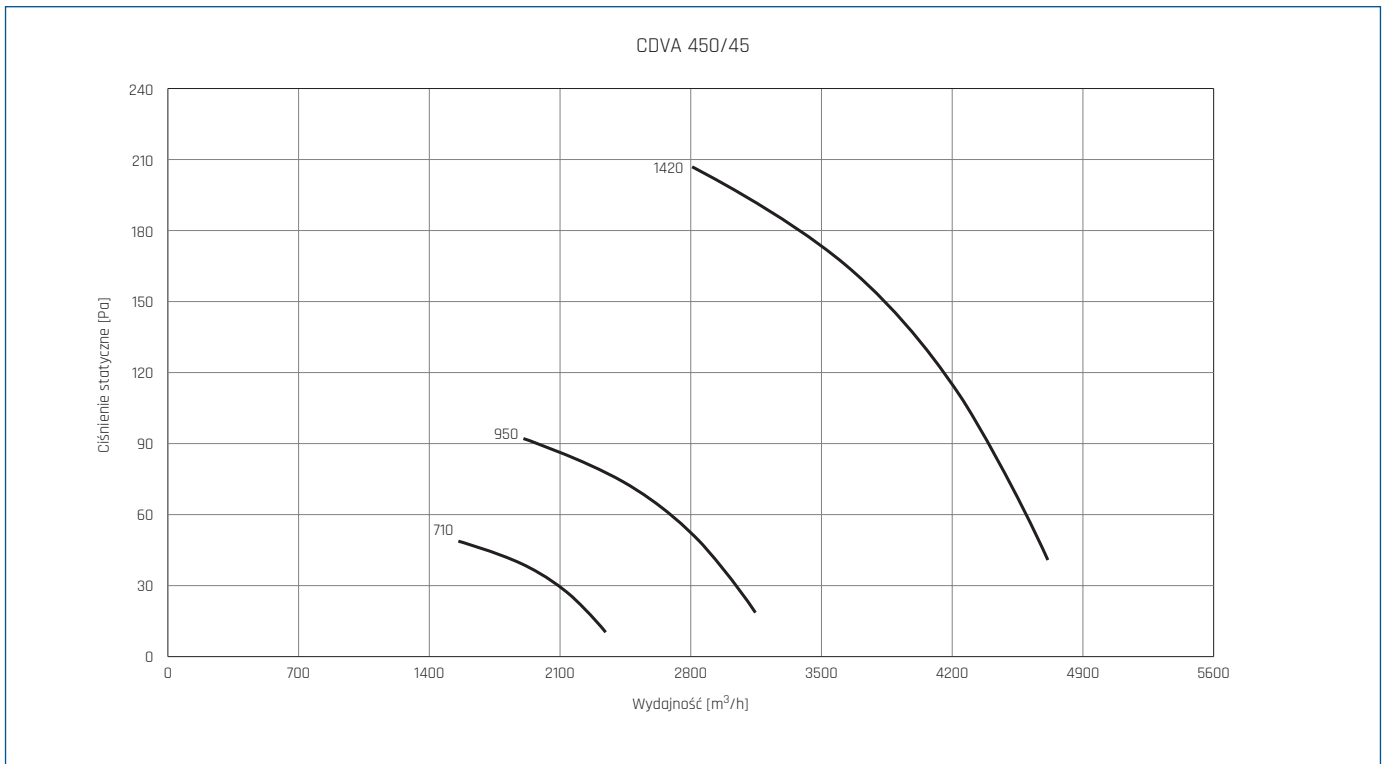
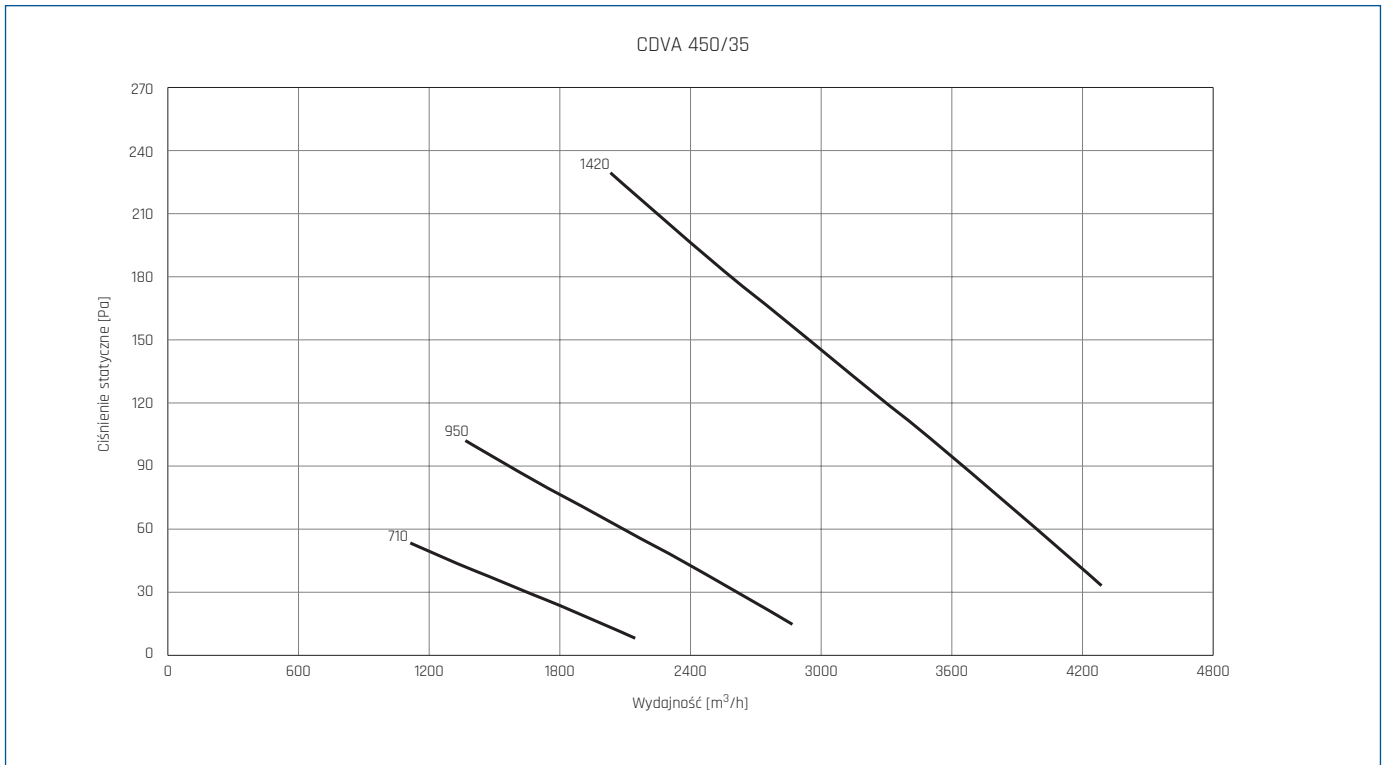

CDVA 450/35

n [obr/min]	L _{WA} [dB(A)]	Hz							
		63	125	250	500	1000	2000	4000	8000
700	63	41	50	57	58	57	55	51	47
900	69	47	56	63	64	63	61	57	53
1400	78	56	65	72	73	72	70	66	62

CDVA 450/45

n [obr/min]	L _{WA} [dB(A)]	Hz							
		63	125	250	500	1000	2000	4000	8000
700	64	42	51	58	59	57	55	52	48
900	70	48	57	64	65	63	64	58	54
1400	79	57	66	73	74	72	70	67	63

Poziom mocy akustycznej L_{WA} [dB(A)], Poziom ciśnienia akustycznego L_{PA} = L_{WA} - 7 dB(A), Odległość 1m.

CHARAKTERYSTYKI PRACY I CHARAKTERYSTYKA AKUSTYCZNA

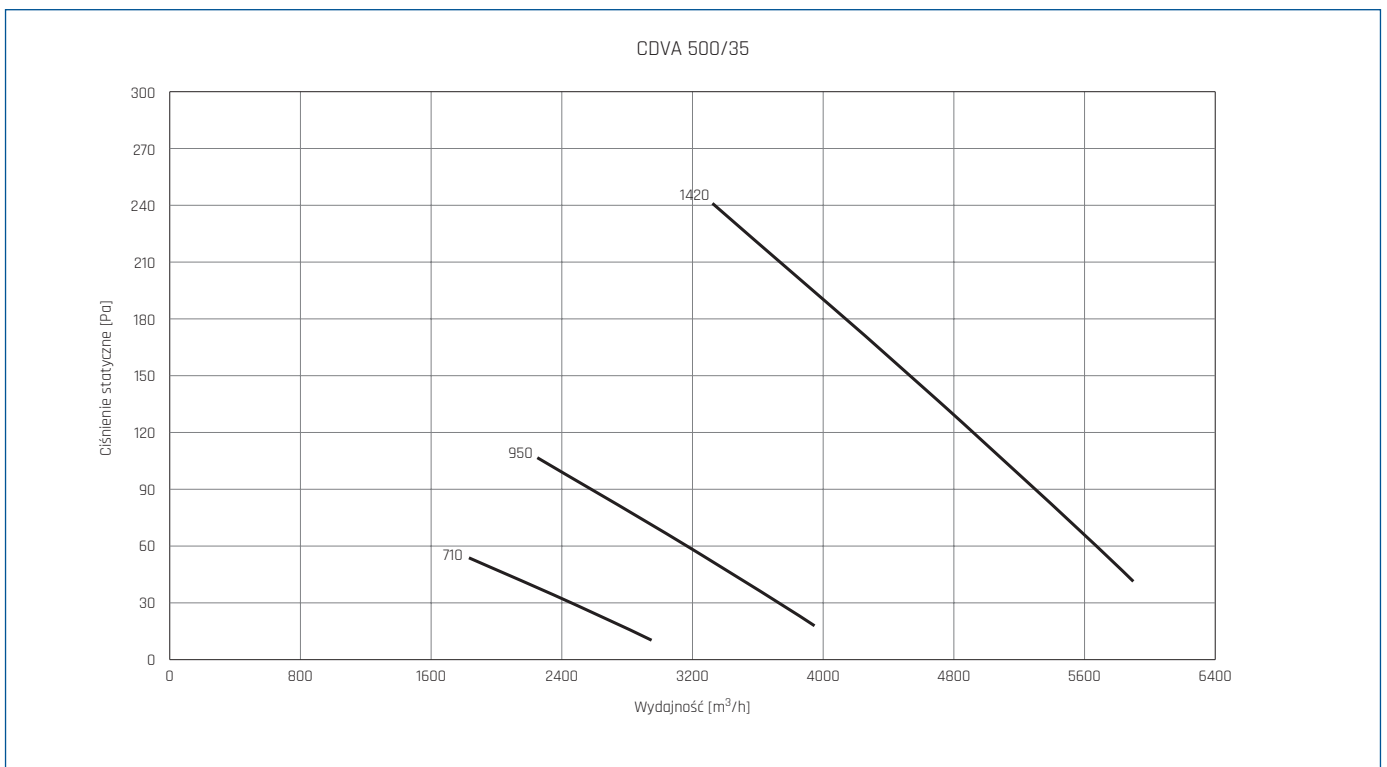
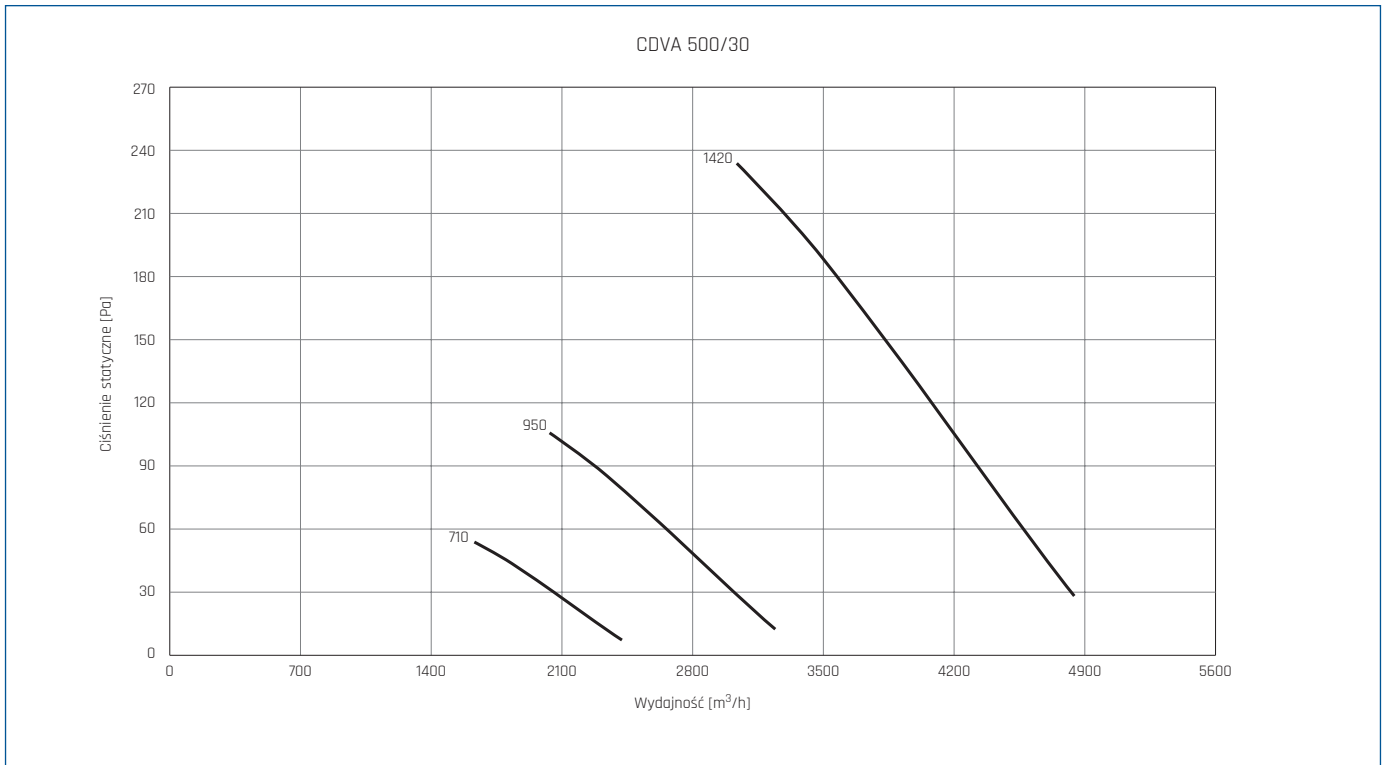

CDVA 500/30

n [obr/min]	L _{WA} [dB(A)]	Hz							
		63	125	250	500	1000	2000	4000	8000
700	63	41	50	57	58	57	55	51	47
900	69	47	56	63	64	63	61	57	53
1400	78	56	65	72	73	72	70	66	62

CDVA 500/35

n [obr/min]	L _{WA} [dB(A)]	Hz							
		63	125	250	500	1000	2000	4000	8000
700	65	43	52	59	60	57	56	53	49
900	71	49	58	65	66	63	62	59	55
1400	80	58	67	74	75	72	71	68	64

Poziom mocy akustycznej L_{WA} [dB(A)], Poziom ciśnienia akustycznego L_{PA} = L_{WA} - 7 dB(A), Odległość 1m.

CHARAKTERYSTYKI PRACY I CHARAKTERYSTYKA AKUSTYCZNA

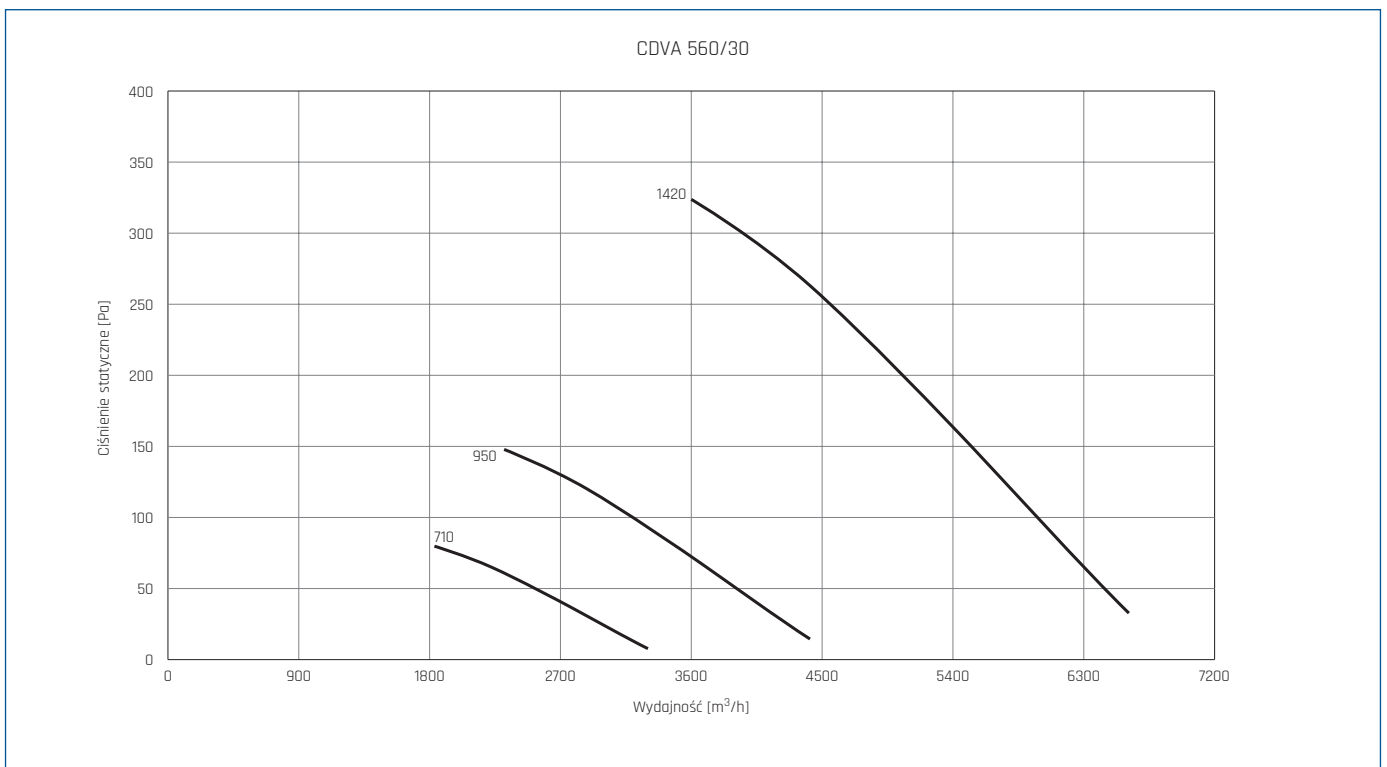
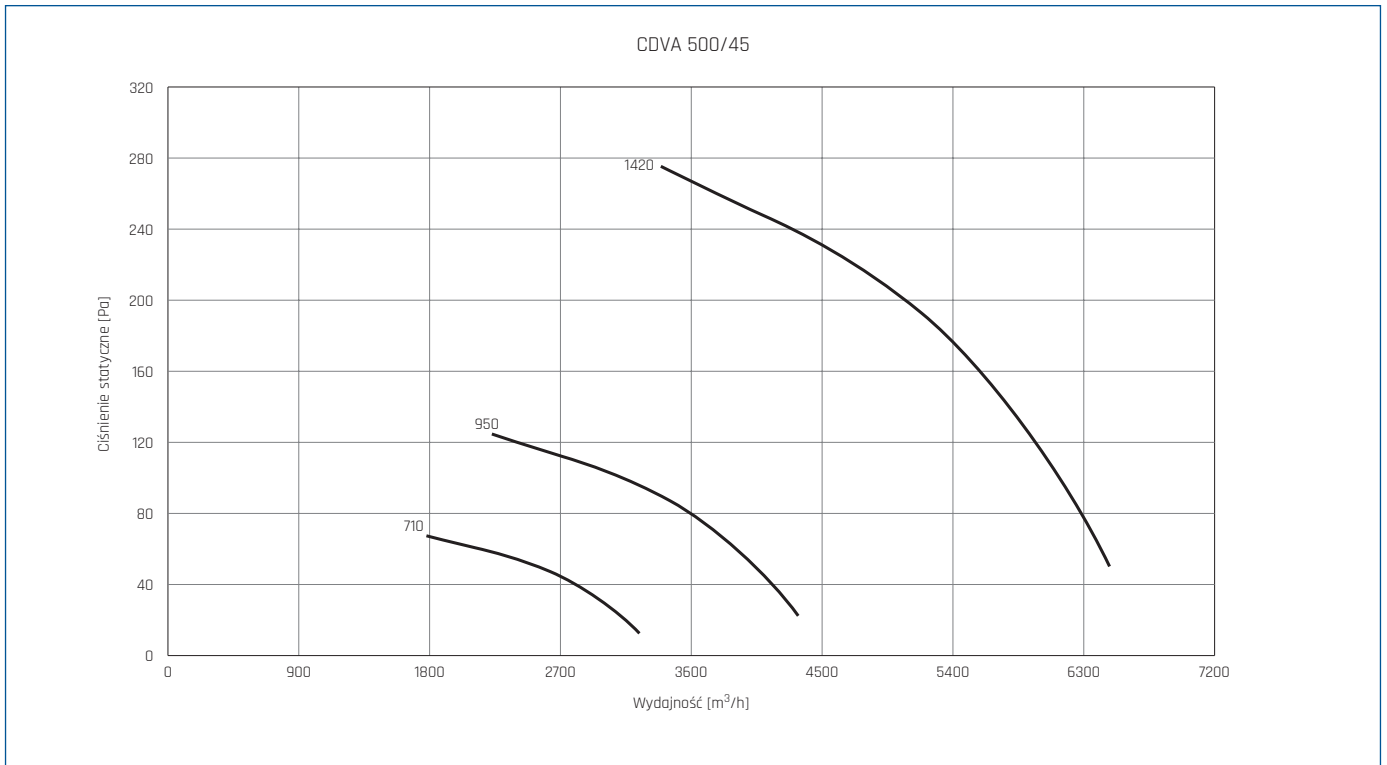

CDVA 500/45

n [obr/min]	L _{WA} [dB(A)]	Hz							
		63	125	250	500	1000	2000	4000	8000
700	65	43	52	59	60	59	57	53	49
900	71	49	58	65	66	65	63	59	55
1400	80	58	67	74	75	74	72	68	64

CDVA 560/30

n [obr/min]	L _{WA} [dB(A)]	Hz							
		63	125	250	500	1000	2000	4000	8000
700	63	41	50	57	58	57	55	51	47
900	69	47	56	63	64	63	61	57	53
1400	78	56	65	72	73	72	70	66	62

Poziom mocy akustycznej L_{WA} [dB(A)], Poziom ciśnienia akustycznego L_{PA} = L_{WA} - 7 dB(A), Odległość 1m.

CHARAKTERYSTYKI PRACY I CHARAKTERYSTYKA AKUSTYCZNA

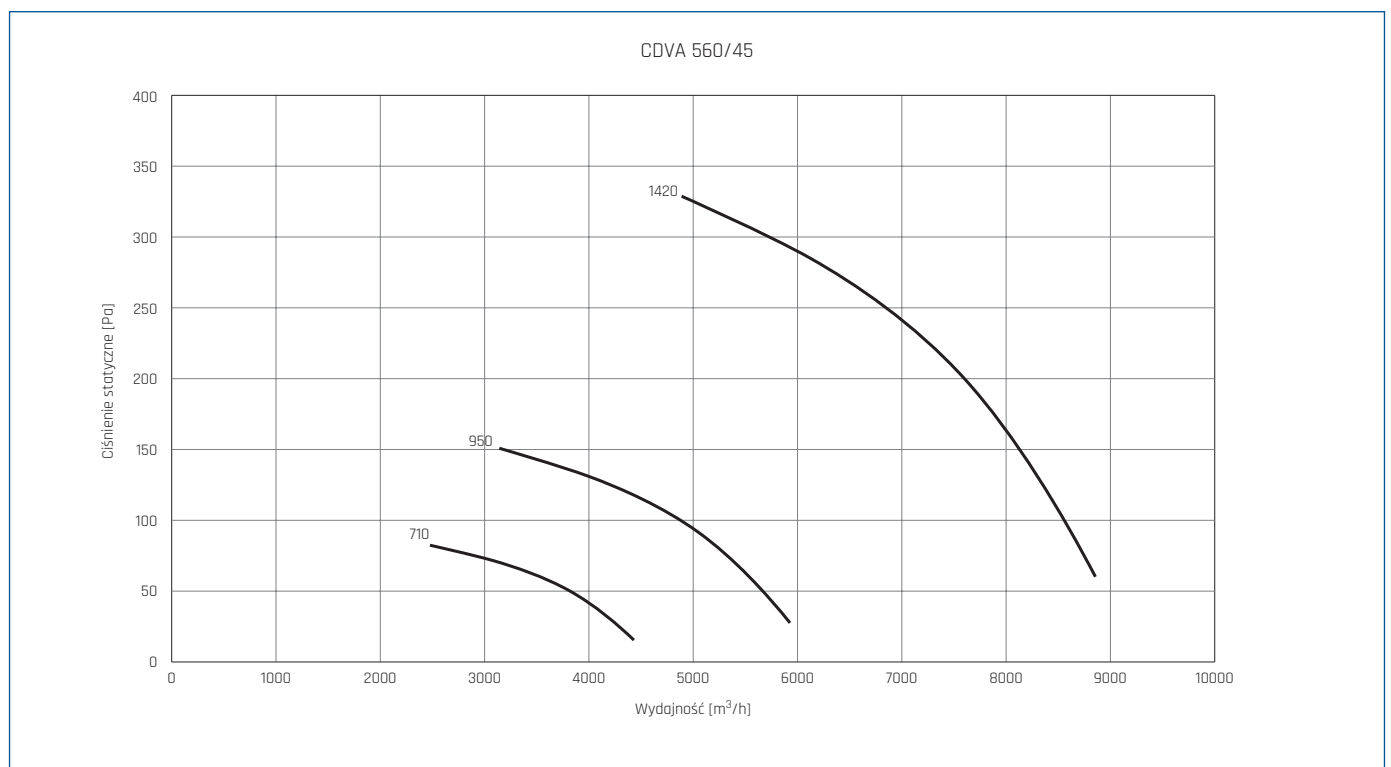
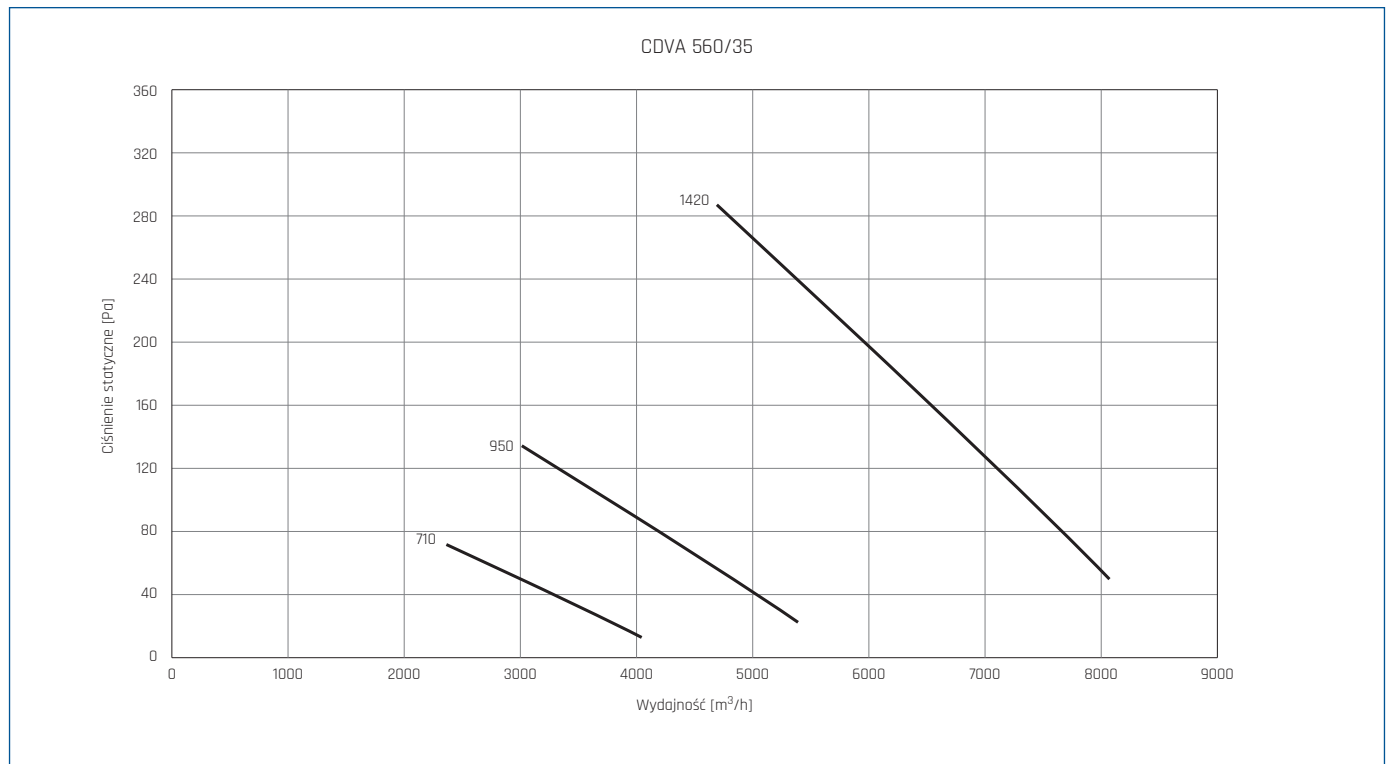

CDVA 560/35

n [obr/min]	L _{WA} [dB(A)]	Hz							
		63	125	250	500	1000	2000	4000	8000
700	63	40	50	56	58	56	55	50	46
900	69	46	56	62	64	62	61	56	52
1400	78	55	65	71	73	71	70	65	61

CDVA 560/45

n [obr/min]	L _{WA} [dB(A)]	Hz							
		63	125	250	500	1000	2000	4000	8000
700	66	44	53	59	61	59	58	54	51
900	72	50	59	65	67	65	64	60	57
1400	81	59	68	74	76	74	73	69	66

Poziom mocy akustycznej L_{WA} [dB(A)], Poziom ciśnienia akustycznego L_{PA} = L_{WA} - 7 dB(A), Odległość 1m.

CHARAKTERYSTYKI PRACY I CHARAKTERYSTYKA AKUSTYCZNA

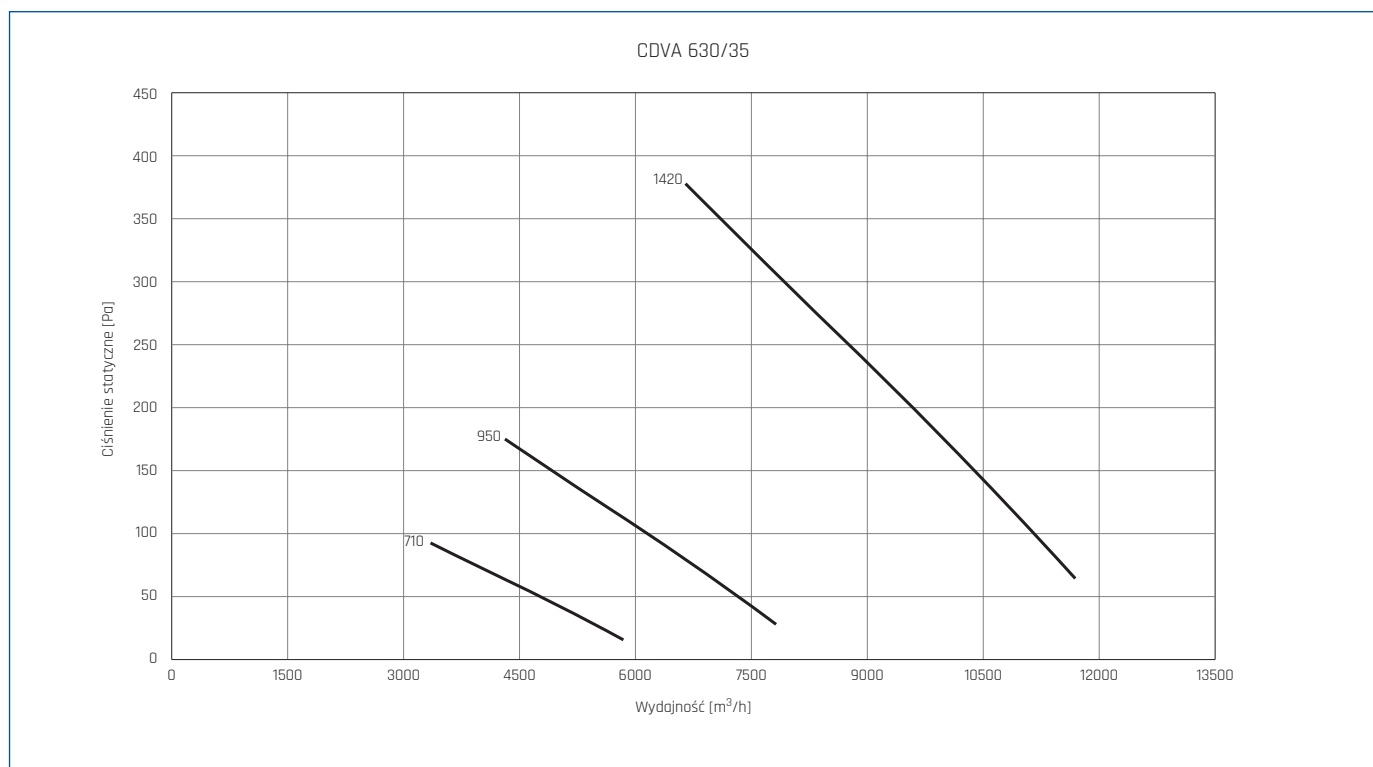
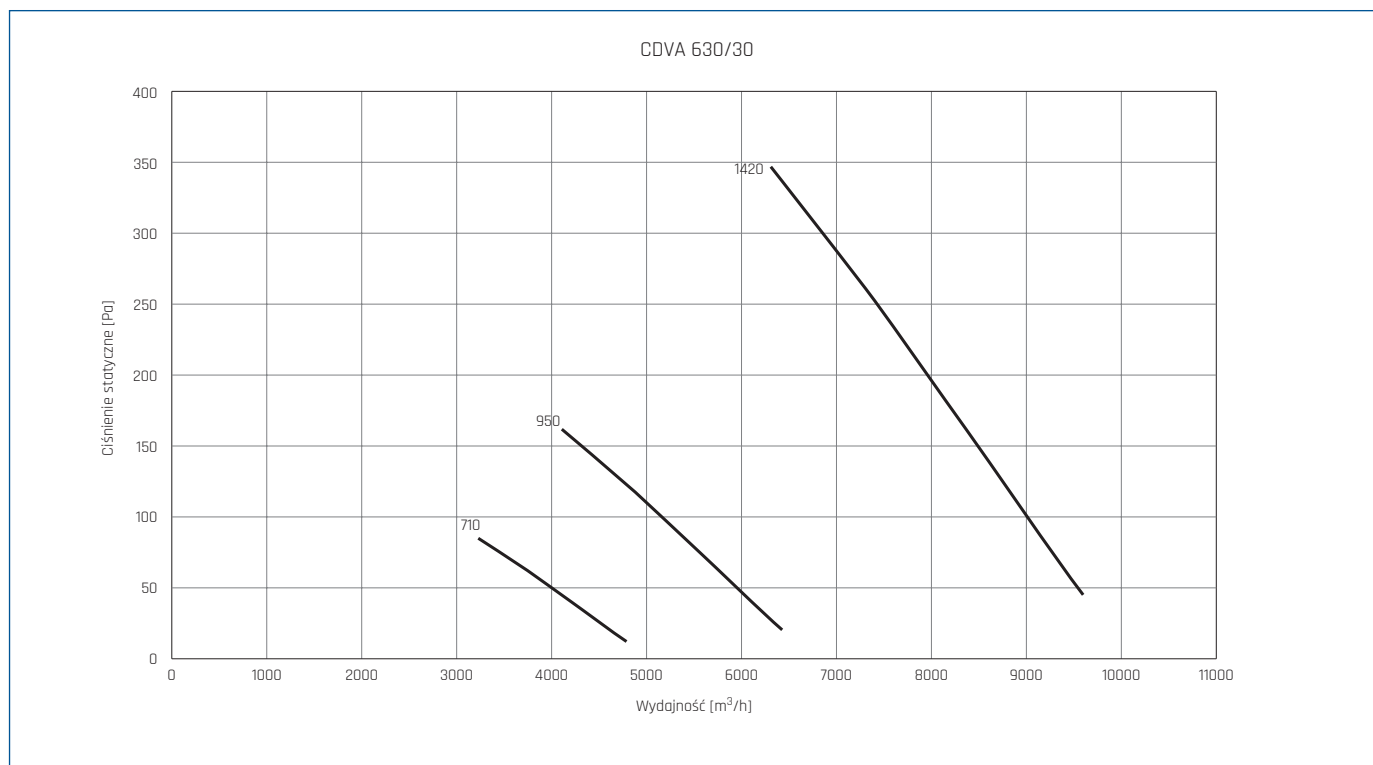

CDVA 630/30

n [obr/min]	L _{WA} [dB(A)]	Hz							
		63	125	250	500	1000	2000	4000	8000
700	69	47	56	63	64	62	61	57	53
900	75	53	62	69	70	68	67	63	59
1400	84	62	71	78	79	77	76	72	68

CDVA 630/35

n [obr/min]	L _{WA} [dB(A)]	Hz							
		63	125	250	500	1000	2000	4000	8000
700	70	48	57	63	65	63	62	58	54
900	76	54	63	69	71	69	68	64	60
1400	85	63	72	78	80	78	77	73	69

Poziom mocy akustycznej L_{WA} [dB(A)], Poziom ciśnienia akustycznego L_{PA} = L_{WA} - 7 dB(A), Odległość 1m.

CHARAKTERYSTYKI PRACY I CHARAKTERYSTYKA AKUSTYCZNA

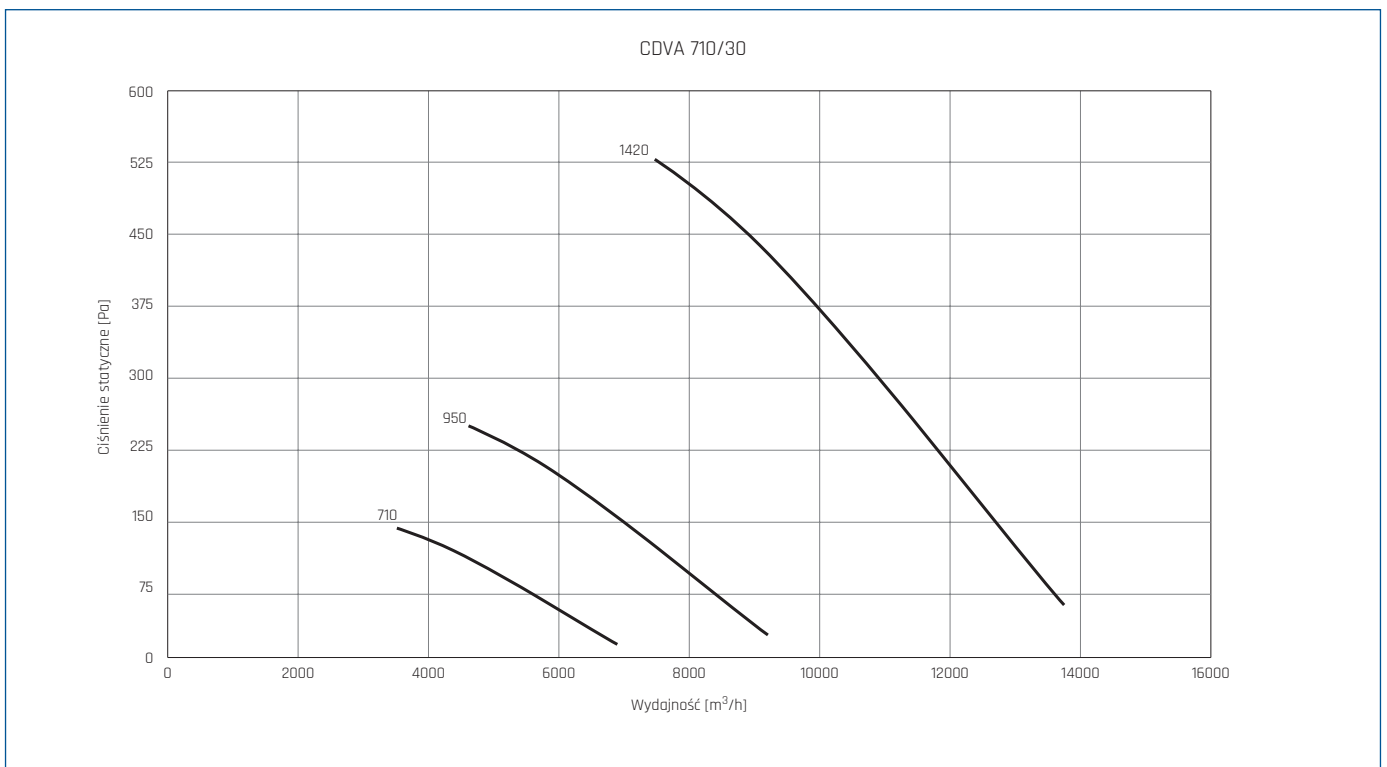
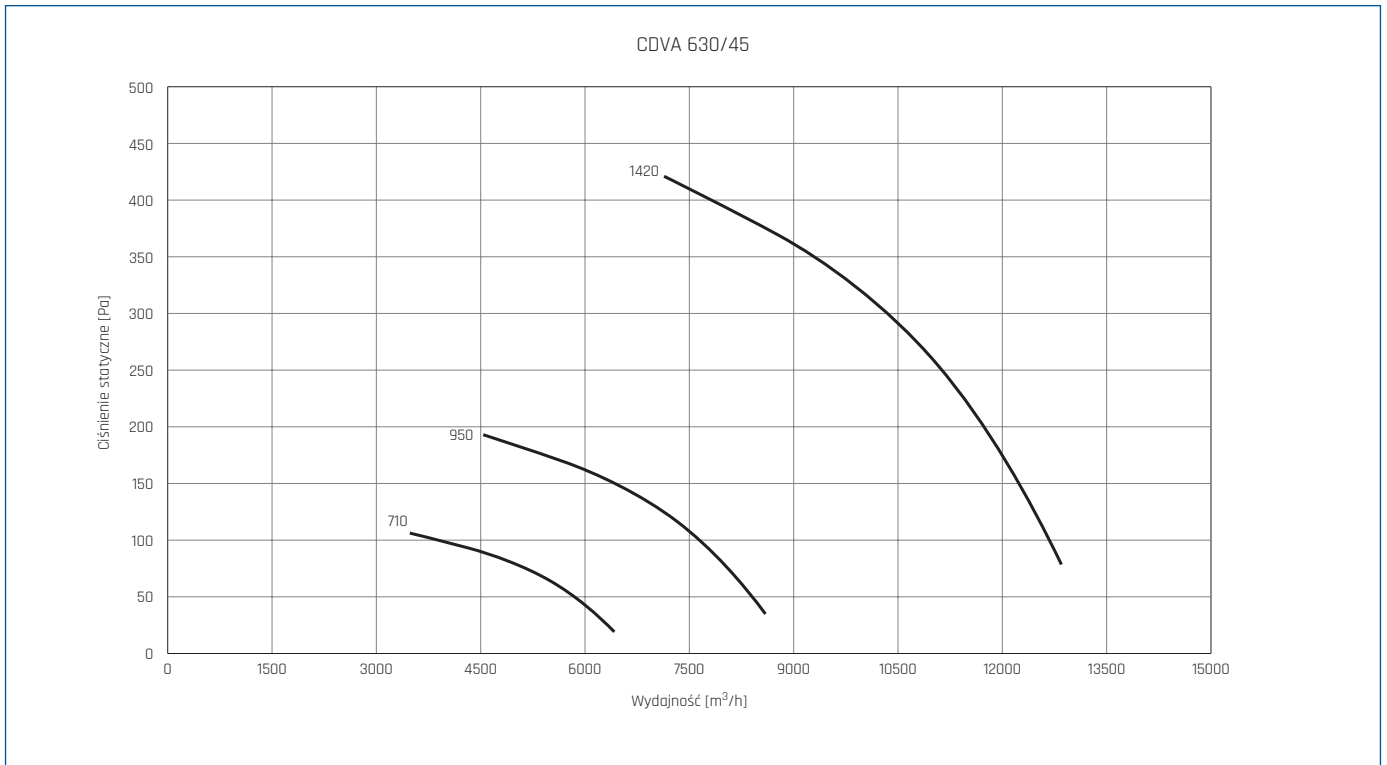

CDVA 630/45

n [obr/min]	L _{WA} [dB(A)]	Hz							
		63	125	250	500	1000	2000	4000	8000
700	71	49	58	65	66	65	62	59	55
900	77	55	64	71	72	71	69	65	61
1400	86	64	73	80	81	80	78	74	70

CDVA 710/30

n [obr/min]	L _{WA} [dB(A)]	Hz								
		63	125	250	500	1000	2000	4000	8000	
700	67	45	54	61	62	61	59	55	51	
900	73	51	60	67	68	67	65	61	57	
1400	82	60	69	76	77	76	74	70	66	

Poziom mocy akustycznej L_{WA} [dB(A)], Poziom ciśnienia akustycznego L_{PA} = L_{WA} - 7 dB(A), Odległość 1m.

CHARAKTERYSTYKI PRACY I CHARAKTERYSTYKA AKUSTYCZNA

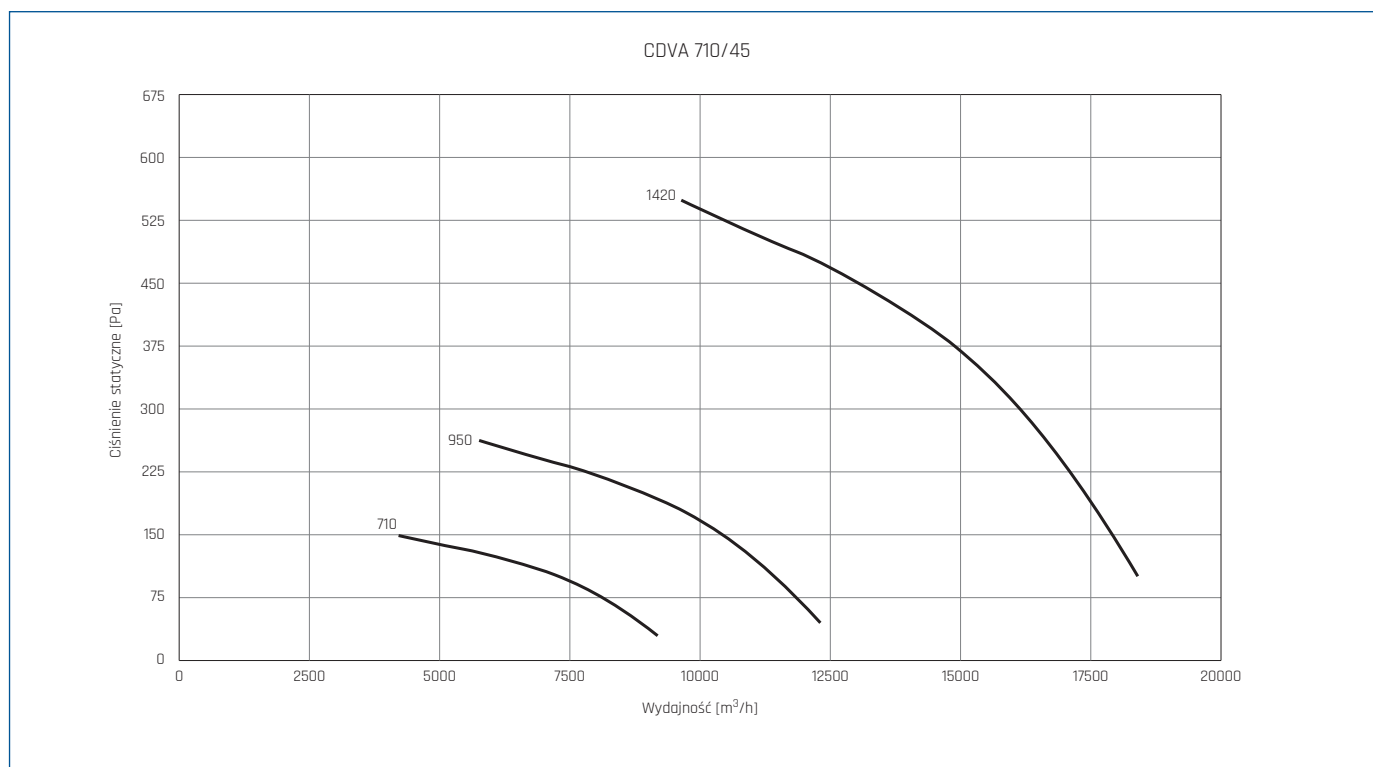
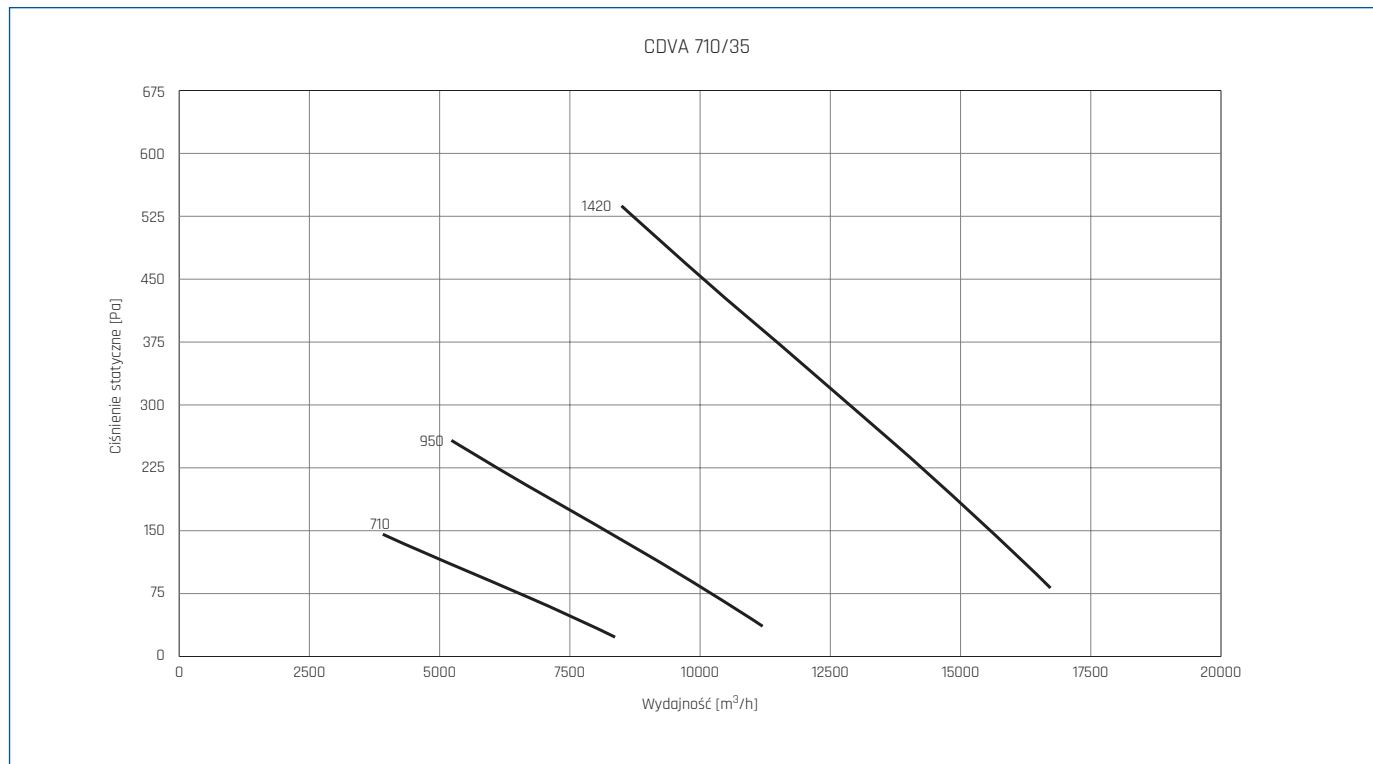

CDVA 710/35

n [obr/min]	L _{WA} [dB(A)]	Hz							
		63	125	250	500	1000	2000	4000	8000
700	70	47	57	63	65	63	61	58	53
900	76	53	63	69	71	69	67	64	59
1400	85	62	72	78	80	78	76	73	68

CDVA 710/45

n [obr/min]	L _{WA} [dB(A)]	Hz							
		63	125	250	500	1000	2000	4000	8000
700	71	49	58	65	66	65	63	59	55
900	77	55	64	71	72	71	69	65	61
1400	86	64	73	80	81	80	78	74	70

Poziom mocy akustycznej L_{WA} [dB(A)], Poziom ciśnienia akustycznego L_{PA} = L_{WA} - 7 dB(A), Odległość 1m.

WYMIARY [mm]

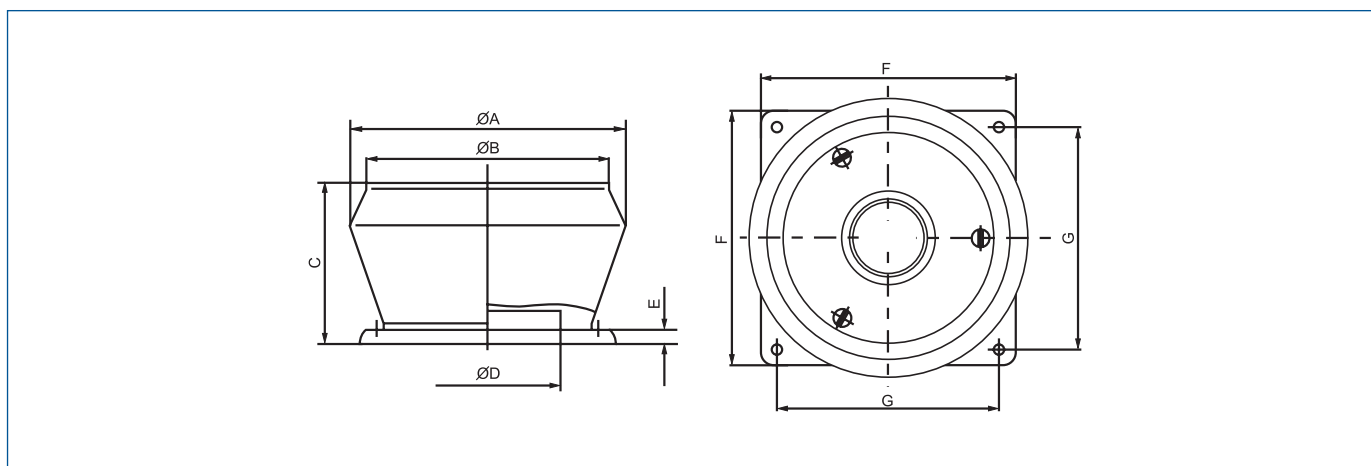

Typ	A	B	C	D	E	F	G
400	782	700	440	402	50	740	620
450	782	700	440	452	50	740	620
500	944	835	530	503	50	877	760
560	944	835	530	562	50	877	760
630	1154	980	620	633	50	1070	940
710	1154	980	620	713	50	1070	940

AKCESORIA MONTAŻOWE

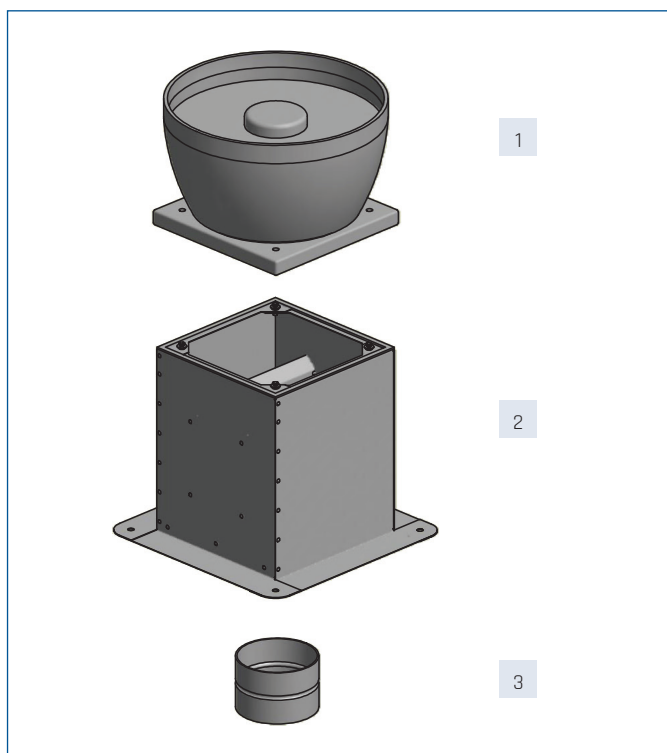

	1	2	3
Wentylator	Podstawa dachowa	Kłapa zwrotna	
CDVA 400	PD CDVA 400, 450	KZ CDVA 400	
CDVA 450	PD CDVA 400, 450	KZ CDVA 450	
CDVA 500	PD CDVA 500, 560	KZ CDVA 500	
CDVA 560	PD CDVA 500, 560	KZ CDVA 560	
CDVA 630	PD CDVA 630, 710	KZ CDVA 630	
CDVA 710	PD CDVA 630, 710	KZ CDVA 710	

Numery artykułów

KZ CDVA 400	44025950	KZ CDVA 500	44025960	KZ CDVA 630	44025970	PD CDVA 400, 450	44025910	PD CDVA 630, 710	44025930
KZ CDVA 450	44025955	KZ CDVA 560	44025965	KZ CDVA 710	44025975	PD CDVA 500, 560	44025920		