

Zastosowanie

Wentylatory HB przeznaczone są do transportu czystego powietrza. Mają wiele zastosowań w przemyśle, gdzie w procesach technologicznych należy dostarczyć niewielką ilość powietrza o wysokim ciśnieniu m.in.:

- dostarczanie powietrza do układów palników gazowych,
- układy filtracyjne,
- transport pneumatyczny,
- układy suszenia,
- układy chłodzenia.

Konstrukcja

- wysoko i bardzo wysokociśnieniowy wentylator promieniowy o napędzie bezpośrednim,
- wirnik z blachy stalowej z łopatkami pochylonymi do tyłu,
- obudowa z blachy stalowej,
- wentylator malowany na kolor niebieski RAL 5010 (kategoria korozyjności C3),
- maksymalna temperatura tłoczonego medium 80°C,
- temperatura otoczenia silnika od -30°C do +60°C (w zależności od modelu - patrz tabela danych technicznych),
- wentylatory występują w standardzie w figurze LG270.

Silnik elektryczny

- asynchroniczny, trójfazowy, 230/400V 50Hz lub 400/690V 50Hz, klasa sprawności IE3,
- stopień ochrony IP55,
- klasa izolacji F,
- silnik przystosowany do regulacji częstotliwościowej.

Wykonania specjalne

- dowolna figura LG/RD,
- malowanie na kolor inny niż standardowy i w wyższej kategorii korozyjności,
- wykonanie z blachy stalowej ocynkowanej, nierdzewnej 1.4301, kwasoodpornej 1.4404,
- silnik na inne niż standardowe napięcie oraz częstotliwość zasilania, o innym stopniu ochrony IP, wyposażony w czujniki lub dodatkowe chłodzenie, o klasie sprawności IE4,
- uszczelnienie między obudową, a silnikiem,
- wykonanie HT - maksymalna temperatura tłoczonego medium wyższa niż standardowa,
- temperatura otoczenia silnika poniżej -30°C oraz powyżej +40°C,
- napęd pasowy, sprzęgło,
- wykonanie przeciwwybuchowe ATEX.

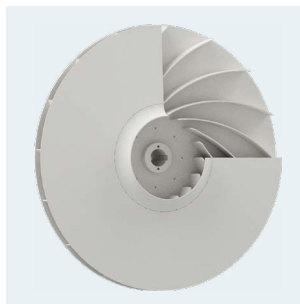
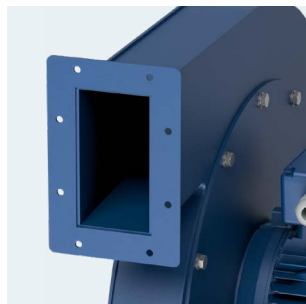
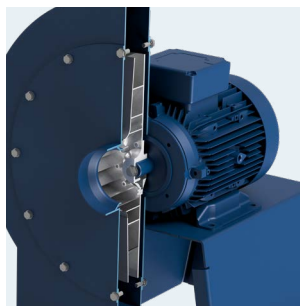

POWIĄZANE PRODUKTY





DANE TECHNICZNE

model wentylatora	wydajność maksymalna	ciśnienie maksymalne	prędkość obrotowa	napięcie nominalne	natężenie znamionowe**	moc silnika	poziom ciśnienia akust.*	temperatura pracy min / max	temperatura otoczenia min / max	masa jednostki	numer artykułu
WENTYLATORY Z SILNIKAMI DWUBIEGUNOWYMI											
HB-2-40A-055T	490 m ³ /h	3 000 Pa	2 790 rpm	3~400 V	1,35 A	0,55 kW	66 dB(A)	-30 / 80 °C	-30 / 40 °C	48,0 kg	436024020
HB-2-40A-075T	760 m ³ /h	3 000 Pa	2 890 rpm	3~400 V	1,7 A	0,75 kW	67 dB(A)	-30 / 80 °C	-30 / 40 °C	52,0 kg	436024021
HB-2-40A-110T	1 220 m ³ /h	3 000 Pa	2 890 rpm	3~400 V	2,5 A	1,1 kW	64 dB(A)	-30 / 80 °C	-30 / 40 °C	53,0 kg	436024022
HB-2-40A-150T	1 350 m ³ /h	3 000 Pa	2 880 rpm	3~400 V	3 A	1,5 kW	62 dB(A)	-30 / 80 °C	-30 / 40 °C	58,0 kg	436024023
HB-2-40B-075T	680 m ³ /h	3 165 Pa	2 890 rpm	3~400 V	1,7 A	0,75 kW	68 dB(A)	-30 / 80 °C	-30 / 40 °C	52,0 kg	436024024
HB-2-40B-110T	1 100 m ³ /h	3 165 Pa	2 890 rpm	3~400 V	2,5 A	1,1 kW	66 dB(A)	-30 / 80 °C	-30 / 40 °C	53,0 kg	436024025
HB-2-40B-150T	1 550 m ³ /h	3 165 Pa	2 880 rpm	3~400 V	3,0 A	1,5 kW	62 dB(A)	-30 / 80 °C	-30 / 40 °C	58,0 kg	436024026
HB-2-45A-110T	770 m ³ /h	3 800 Pa	2 890 rpm	3~400 V	2,5 A	1,1 kW	70 dB(A)	-30 / 80 °C	-30 / 40 °C	60,0 kg	436024520
HB-2-45A-150T	1 200 m ³ /h	3 800 Pa	2 880 rpm	3~400 V	3,0 A	1,5 kW	70 dB(A)	-30 / 80 °C	-30 / 40 °C	65,0 kg	436024521
HB-2-45A-220T	1 920 m ³ /h	3 800 Pa	2 910 rpm	3~400 V	4,3 A	2,2 kW	65 dB(A)	-30 / 80 °C	-30 / 40 °C	66,0 kg	436024522
HB-2-45B-110T	700 m ³ /h	3 990 Pa	2 890 rpm	3~400 V	2,5 A	1,1 kW	71 dB(A)	-30 / 80 °C	-30 / 40 °C	60,0 kg	436024523
HB-2-45B-150T	1 080 m ³ /h	4 005 Pa	2 925 rpm	3~400 V	3,0 A	1,5 kW	70 dB(A)	-30 / 80 °C	-30 / 40 °C	65,0 kg	436024524
HB-2-45B-220T	1 720 m ³ /h	4 005 Pa	2 910 rpm	3~400 V	4,3 A	2,2 kW	69 dB(A)	-30 / 80 °C	-30 / 40 °C	66,0 kg	436024525
HB-2-45B-300T	2 190 m ³ /h	4 005 Pa	2 880 rpm	3~400 V	5,3 A	3,0 kW	66 dB(A)	-30 / 80 °C	-30 / 40 °C	73,0 kg	436024526
HB-2-50A-150T	800 m ³ /h	4 650 Pa	2 880 rpm	3~400 V	3,0 A	1,5 kW	72 dB(A)	-30 / 80 °C	-30 / 40 °C	73,0 kg	436025020
HB-2-50A-220T	1 310 m ³ /h	4 700 Pa	2 910 rpm	3~400 V	4,3 A	2,2 kW	73 dB(A)	-30 / 80 °C	-30 / 40 °C	75,0 kg	436025021
HB-2-50A-300T	2 100 m ³ /h	4 700 Pa	2 915 rpm	3~400 V	5,3 A	3,0 kW	72 dB(A)	-30 / 80 °C	-30 / 40 °C	81,0 kg	436025022
HB-2-50A-400T	2 600 m ³ /h	4 700 Pa	2 895 rpm	3~400 V	7,3 A	4,0 kW	70 dB(A)	-30 / 80 °C	-30 / 40 °C	92,0 kg	436025023
HB-2-50B-220T	1 230 m ³ /h	4 945 Pa	2 910 rpm	3~400 V	4,3 A	2,2 kW	74 dB(A)	-30 / 80 °C	-30 / 40 °C	75,0 kg	436025024
HB-2-50B-300T	1 850 m ³ /h	4 945 Pa	2 915 rpm	3~400 V	5,3 A	3,0 kW	75 dB(A)	-30 / 80 °C	-30 / 40 °C	81,0 kg	436025025
HB-2-50B-400T	2 730 m ³ /h	4 945 Pa	2 895 rpm	3~400 V	7,3 A	4,0 kW	72 dB(A)	-30 / 80 °C	-30 / 40 °C	92,0 kg	436025026
HB-2-56A-300T	1 350 m ³ /h	5 900 Pa	2 915 rpm	3~400 V	5,3 A	3,0 kW	76 dB(A)	-30 / 80 °C	-30 / 40 °C	93,0 kg	436025620
HB-2-56A-400T	2 000 m ³ /h	5 900 Pa	2 895 rpm	3~400 V	7,3 A	4,0 kW	77 dB(A)	-30 / 80 °C	-30 / 40 °C	104,0 kg	436025621
HB-2-56A-550T	3 050 m ³ /h	5 900 Pa	2 940 rpm	3~400 V	10 A	5,5 kW	75 dB(A)	-30 / 80 °C	-30 / 40 °C	123,0 kg	436025622
HB-2-56A-750T	3 800 m ³ /h	5 900 Pa	2 930 rpm	3~400 V	13,3 A	7,5 kW	73 dB(A)	-30 / 80 °C	-30 / 40 °C	132,0 kg	436025623
HB-2-56B-300T	1 170 m ³ /h	6 150 Pa	2 915 rpm	3~400 V	5,3 A	3,0 kW	76 dB(A)	-30 / 80 °C	-30 / 40 °C	93,0 kg	436025624
HB-2-56B-400T	1 800 m ³ /h	6 200 Pa	2 895 rpm	3~400 V	7,3 A	4,0 kW	78 dB(A)	-30 / 80 °C	-30 / 40 °C	104,0 kg	436025625
HB-2-56B-550T	2 700 m ³ /h	6 200 Pa	2 940 rpm	3~400 V	10 A	5,5 kW	78 dB(A)	-30 / 80 °C	-30 / 40 °C	123,0 kg	436025626
HB-2-56B-750T	4 100 m ³ /h	6 200 Pa	2 930 rpm	3~400 V	13,3 A	7,5 kW	74 dB(A)	-30 / 80 °C	-30 / 40 °C	132,0 kg	436025627
HB-2-63A-550T	1 950 m ³ /h	7 450 Pa	2 940 rpm	3~400 V	10 A	5,5 kW	80 dB(A)	-30 / 80 °C	-30 / 40 °C	144,0 kg	436026320
HB-2-63A-750T	3 000 m ³ /h	7 450 Pa	2 930 rpm	3~400 V	13,3 A	7,5 kW	81 dB(A)	-30 / 80 °C	-30 / 40 °C	153,0 kg	436026321
HB-2-63A-1100T	4 950 m ³ /h	7 450 Pa	2 925 rpm	3~400 V	19,3 A	11,0 kW	78 dB(A)	-30 / 80 °C	-30 / 40 °C	212,0 kg	436026322
HB-2-63B-550T	1 600 m ³ /h	7 800 Pa	2 940 rpm	3~400 V	10 A	5,5 kW	80 dB(A)	-30 / 80 °C	-30 / 40 °C	144,0 kg	436026323
HB-2-63B-750T	2 700 m ³ /h	7 850 Pa	2 930 rpm	3~400 V	13,3 A	7,5 kW	82 dB(A)	-30 / 80 °C	-30 / 40 °C	153,0 kg	436026324
HB-2-63B-1100T	4 500 m ³ /h	7 850 Pa	2 925 rpm	3~400 V	19,3 A	11,0 kW	80 dB(A)	-30 / 80 °C	-30 / 40 °C	212,0 kg	436026325
HB-2-63B-1500T	6 000 m ³ /h	7 850 Pa	2 940 rpm	3~400 V	26 A	15,0 kW	77 dB(A)	-30 / 80 °C	-30 / 40 °C	221,0 kg	436026326
HB-2-71A-1100T	3 100 m ³ /h	9 500 Pa	2 925 rpm	3~400 V	19,3 A	11,0 kW	84 dB(A)	-30 / 80 °C	-30 / 40 °C	233,0 kg	436027120
HB-2-71A-1500T	4 850 m ³ /h	9 500 Pa	2 940 rpm	3~400 V	26 A	15,0 kW	84 dB(A)	-30 / 80 °C	-30 / 40 °C	244,0 kg	436027121
HB-2-71A-1850T	6 250 m ³ /h	9 500 Pa	2 940 rpm	3~400 V	32,1 A	18,5 kW	82 dB(A)	-30 / 80 °C	-30 / 40 °C	251,0 kg	436027122
HB-2-71A-2200T	7 450 m ³ /h	9 500 Pa	2 950 rpm	3~400 V	38,1 A	22,0 kW	80 dB(A)	-30 / 80 °C	-30 / 40 °C	302,0 kg	436027123
HB-2-71B-1100T	3 000 m ³ /h	9 970 Pa	2 925 rpm	3~400 V	19,3 A	11,0 kW	85 dB(A)	-30 / 80 °C	-30 / 40 °C	233,0 kg	436027124
HB-2-71B-1500T	4 600 m ³ /h	9 970 Pa	2 940 rpm	3~400 V	26 A	15,0 kW	86 dB(A)	-30 / 80 °C	-30 / 40 °C	244,0 kg	436027125
HB-2-71B-1850T	5 650 m ³ /h	9 970 Pa	2 940 rpm	3~400 V	32,1 A	18,5 kW	85 dB(A)	-30 / 80 °C	-30 / 40 °C	251,0 kg	436027126

*pomiar wykonany w odległości 1,5m od wylotu, dla Q = 2/3*Qmax

** wartość prądu znamionowego może się różnić w zależności od producenta zastosowanego silnika elektrycznego.



DANE TECHNICZNE

model wentylatora	wydajność maksymalna	ciśnienie maksymalne	prędkość obrotowa	napięcie nominalne	natężenie znamionowe**	moc silnika	poziom ciśnienia akust.*	temperatura pracy min / max	temperatura otoczenia min / max	masa jednostki	numer artykułu
HB-2-71B-2200T	7 390 m ³ /h	9 970 Pa	2 950 rpm	3~400 V	38,1 A	22,0 kW	84 dB(A)	-30 / 80 °C	-30 / 40 °C	302,0 kg	436027127
HB-2-80A-1850T	3 950 m ³ /h	12 050 Pa	2 940 rpm	3~400 V	32,1 A	18,5 kW	86 dB(A)	-30 / 80 °C	-30 / 40 °C	273,0 kg	436028020
HB-2-80A-2200T	5 200 m ³ /h	12 050 Pa	2 950 rpm	3~400 V	38,1 A	22,0 kW	87 dB(A)	-30 / 80 °C	-30 / 40 °C	327,0 kg	436028021
HB-2-80A-3000T	7 950 m ³ /h	12 050 Pa	2 965 rpm	3~400 V	53 A	30,0 kW	88 dB(A)	-30 / 80 °C	-30 / 40 °C	395,0 kg	436028022
HB-2-80A-3700T	10 700 m ³ /h	12 050 Pa	2 955 rpm	3~400 V	65 A	37,0 kW	84 dB(A)	-30 / 80 °C	-30 / 40 °C	410,0 kg	436028023
HB-2-80B-1850T	3 900 m ³ /h	12 500 Pa	2 940 rpm	3~400 V	32,1 A	18,5 kW	88 dB(A)	-30 / 80 °C	-30 / 40 °C	273,0 kg	436028024
HB-2-80B-2200T	4 500 m ³ /h	12 660 Pa	2 950 rpm	3~400 V	38,1 A	22,0 kW	89 dB(A)	-30 / 80 °C	-30 / 40 °C	327,0 kg	436028025
HB-2-80B-3000T	7 200 m ³ /h	12 660 Pa	2 965 rpm	3~400 V	53 A	30,0 kW	89 dB(A)	-30 / 80 °C	-30 / 40 °C	395,0 kg	436028026
HB-2-80B-3700T	9 150 m ³ /h	12 660 Pa	2 955 rpm	3~400 V	65 A	37,0 kW	87 dB(A)	-30 / 80 °C	-30 / 40 °C	410,0 kg	436028027
HB-2-80B-4500T	12 020 m ³ /h	12 660 Pa	2 960 rpm	3~400 V	77 A	45,0 kW	85 dB(A)	-30 / 80 °C	-30 / 40 °C	525,0 kg	436028028
HB-2-90A-3000T	4 800 m ³ /h	15 250 Pa	2 965 rpm	3~400 V	53 A	30,0 kW	90 dB(A)	-30 / 80 °C	-30 / 40 °C	439,0 kg	436029020
HB-2-90A-3700T	6 400 m ³ /h	15 250 Pa	2 955 rpm	3~400 V	65 A	37,0 kW	91 dB(A)	-30 / 80 °C	-30 / 40 °C	454,0 kg	436029021
HB-2-90A-4500T	8 500 m ³ /h	15 250 Pa	2 960 rpm	3~400 V	77 A	45,0 kW	92 dB(A)	-30 / 80 °C	-30 / 40 °C	576,0 kg	436029022
HB-2-90A-5500T	11 700 m ³ /h	15 250 Pa	2 970 rpm	3~400 V	92 A	55,0 kW	90 dB(A)	-30 / 80 °C	-30 / 40 °C	611,0 kg	436029023
HB-2-90A-7500T	15 200 m ³ /h	15 250 Pa	2 960 rpm	3~400 V	127 A	75,0 kW	88 dB(A)	-30 / 80 °C	-30 / 40 °C	761,0 kg	446029024
HB-2-90B-3000T	4 500 m ³ /h	16 000 Pa	2 965 rpm	3~400 V	53 A	30,0 kW	91 dB(A)	-30 / 80 °C	-30 / 40 °C	439,0 kg	436029025
HB-2-90B-3700T	6 400 m ³ /h	16 020 Pa	2 955 rpm	3~400 V	65 A	37,0 kW	92 dB(A)	-30 / 80 °C	-30 / 40 °C	454,0 kg	436029026
HB-2-90B-4500T	8 400 m ³ /h	16 020 Pa	2 960 rpm	3~400 V	77 A	45,0 kW	93 dB(A)	-30 / 80 °C	-30 / 40 °C	576,0 kg	436029027
HB-2-90B-5500T	10 500 m ³ /h	16 020 Pa	2 970 rpm	3~400 V	92 A	55,0 kW	93 dB(A)	-30 / 80 °C	-30 / 40 °C	611,0 kg	436029028
HB-2-90B-7500T	15 585 m ³ /h	16 020 Pa	2 960 rpm	3~400 V	127 A	75,0 kW	91 dB(A)	-30 / 80 °C	-30 / 40 °C	761,0 kg	446029029
HB-2-100A-5500T	8 000 m ³ /h	18 800 Pa	2 970 rpm	3~400 V	92 A	55,0 kW	94 dB(A)	-30 / 80 °C	-30 / 40 °C	540,0 kg	436021020
HB-2-100A-7500T	12 000 m ³ /h	18 800 Pa	2 960 rpm	3~400 V	127 A	75,0 kW	95 dB(A)	-30 / 80 °C	-30 / 40 °C	789,0 kg	446021021
HB-2-100A-9000T	15 000 m ³ /h	18 800 Pa	2 980 rpm	3~400 V	150 A	90,0 kW	95 dB(A)	-30 / 80 °C	-30 / 40 °C	879,0 kg	446021022
HB-2-100A-11000T	19 800 m ³ /h	18 800 Pa	2 980 rpm	3~400 V	183 A	110,0 kW	93 dB(A)	-30 / 80 °C	-30 / 40 °C	1 026,0 kg	446021023
HB-2-100B-5500T	7 000 m ³ /h	19 500 Pa	2 970 rpm	3~400 V	92 A	55,0 kW	94 dB(A)	-30 / 80 °C	-30 / 40 °C	540,0 kg	436021024
HB-2-100B-7500T	10 600 m ³ /h	19 780 Pa	2 960 rpm	3~400 V	127 A	75,0 kW	96 dB(A)	-30 / 80 °C	-30 / 40 °C	789,0 kg	446021025
HB-2-100B-9000T	13 700 m ³ /h	19 780 Pa	2 980 rpm	3~400 V	150 A	90,0 kW	96 dB(A)	-30 / 80 °C	-30 / 40 °C	879,0 kg	446021026
HB-2-100B-11000T	18 000 m ³ /h	19 780 Pa	2 980 rpm	3~400 V	183 A	110,0 kW	94 dB(A)	-30 / 80 °C	-30 / 40 °C	1 026,0 kg	446021027
HB-2-100B-13200T	22 860 m ³ /h	19 780 Pa	2 975 rpm	3~400 V	222 A	132,0 kW	92 dB(A)	-30 / 80 °C	-30 / 40 °C	1 196,0 kg	446021028

WENTYLATORY Z SILNIKAMI CZTEROBIEGUNOWYMI

HB-4-40A-009T	340 m ³ /h	725 Pa	1 380 rpm	3~400 V	0,35 A	0,09 kW	52 dB(A)	-30 / 80 °C	-30 / 40 °C	44,0 kg	436024040
HB-4-40A-012T	530 m ³ /h	725 Pa	1 380 rpm	3~400 V	0,45 A	0,12 kW	52 dB(A)	-30 / 80 °C	-30 / 40 °C	45,0 kg	436024041
HB-4-40A-018T	660 m ³ /h	725 Pa	1 380 rpm	3~400 V	0,65 A	0,18 kW	49 dB(A)	-30 / 80 °C	-30 / 40 °C	45,0 kg	436024042
HB-4-40B-009T	340 m ³ /h	765 Pa	1 380 rpm	3~400 V	0,35 A	0,09 kW	52 dB(A)	-30 / 80 °C	-15 / 40 °C	44,0 kg	436024043
HB-4-40B-012T	500 m ³ /h	765 Pa	1 380 rpm	3~400 V	0,45 A	0,12 kW	52 dB(A)	-30 / 80 °C	-15 / 40 °C	45,0 kg	436024044
HB-4-40B-018T	760 m ³ /h	765 Pa	1 380 rpm	3~400 V	0,65 A	0,18 kW	47 dB(A)	-30 / 80 °C	-15 / 40 °C	45,0 kg	436024045
HB-4-45A-012T	340 m ³ /h	920 Pa	1 380 rpm	3~400 V	0,45 A	0,12 kW	56 dB(A)	-30 / 80 °C	-30 / 40 °C	52,0 kg	436024540
HB-4-45A-018T	600 m ³ /h	920 Pa	1 380 rpm	3~400 V	0,65 A	0,18 kW	56 dB(A)	-30 / 80 °C	-30 / 40 °C	53,0 kg	436024541
HB-4-45A-025T	930 m ³ /h	920 Pa	1 380 rpm	3~400 V	0,85 A	0,25 kW	52 dB(A)	-30 / 80 °C	-30 / 40 °C	54,0 kg	436024542
HB-4-45B-018T	590 m ³ /h	970 Pa	1 380 rpm	3~400 V	0,65 A	0,18 kW	56 dB(A)	-30 / 80 °C	-15 / 40 °C	52,0 kg	436024543
HB-4-45B-025T	840 m ³ /h	970 Pa	1 380 rpm	3~400 V	0,85 A	0,25 kW	54 dB(A)	-30 / 80 °C	-15 / 40 °C	53,0 kg	436024544
HB-4-45B-037T	1 080 m ³ /h	970 Pa	1 370 rpm	3~400 V	1,15 A	0,37 kW	51 dB(A)	-30 / 80 °C	-15 / 40 °C	54,0 kg	436024545
HB-4-50A-018T	430 m ³ /h	1 130 Pa	1 380 rpm	3~400 V	0,65 A	0,18 kW	58 dB(A)	-30 / 80 °C	-30 / 40 °C	60,0 kg	436025040
HB-4-50A-025T	640 m ³ /h	1 130 Pa	1 380 rpm	3~400 V	0,85 A	0,25 kW	59 dB(A)	-30 / 80 °C	-30 / 40 °C	61,0 kg	436025041
HB-4-50A-037T	1 050 m ³ /h	1 130 Pa	1 370 rpm	3~400 V	1,15 A	0,37 kW	58 dB(A)	-30 / 80 °C	-30 / 40 °C	62,0 kg	436025042
HB-4-50A-055T	1 290 m ³ /h	1 130 Pa	1 400 rpm	3~400 V	1,7 A	0,55 kW	56 dB(A)	-30 / 80 °C	-30 / 40 °C	63,0 kg	436025043

*pomiar wykonany w odległości 1,5m od wylotu, dla 0 = 2/3*Qmax

** wartość prądu znamionowego może się różnić w zależności od producenta zastosowanego silnika elektrycznego.



DANE TECHNICZNE

model wentylatora	wydajność maksymalna	ciśnienie maksymalne	prędkość obrotowa	napięcie nominalne	natężenie znamionowe**	moc silnika	poziom ciśnienia akust.*	temperatura pracy min / max	temperatura otoczenia min / max	masa jednostki	numer artykułu
HB-4-50B-025T	600 m ³ /h	1 195 Pa	1 380 rpm	3~400 V	0,85 A	0,25 kW	59 dB(A)	-30 / 80 °C	-15 / 40 °C	61,0 kg	436025044
HB-4-50B-037T	1 000 m ³ /h	1 195 Pa	1 370 rpm	3~400 V	1,15 A	0,37 kW	58 dB(A)	-30 / 80 °C	-15 / 40 °C	62,0 kg	436025045
HB-4-50B-055T	1 470 m ³ /h	1 195 Pa	1 400 rpm	3~400 V	1,7 A	0,55 kW	54 dB(A)	-30 / 80 °C	-30 / 60 °C	63,0 kg	436025046
HB-4-56A-037T	720 m ³ /h	1 420 Pa	1 370 rpm	3~400 V	1,15 A	0,37 kW	61 dB(A)	-30 / 80 °C	-30 / 40 °C	74,0 kg	436025640
HB-4-56A-055T	1 200 m ³ /h	1 420 Pa	1 400 rpm	3~400 V	1,7 A	0,55 kW	62 dB(A)	-30 / 80 °C	-30 / 40 °C	75,0 kg	436025641
HB-4-56A-075T	1 800 m ³ /h	1 420 Pa	1 430 rpm	3~400 V	2,1 A	0,75 kW	58 dB(A)	-30 / 80 °C	-30 / 40 °C	79,0 kg	436025642
HB-4-56B-037T	630 m ³ /h	1 500 Pa	1 370 rpm	3~400 V	1,15 A	0,37 kW	63 dB(A)	-30 / 80 °C	-15 / 40 °C	74,0 kg	436025643
HB-4-56B-055T	1 150 m ³ /h	1 500 Pa	1 400 rpm	3~400 V	1,7 A	0,55 kW	63 dB(A)	-30 / 80 °C	-30 / 60 °C	75,0 kg	436025644
HB-4-56B-075T	1 600 m ³ /h	1 500 Pa	1 430 rpm	3~400 V	2,1 A	0,75 kW	61 dB(A)	-30 / 80 °C	-30 / 60 °C	79,0 kg	436025645
HB-4-56B-110T	2 170 m ³ /h	1 500 Pa	1 430 rpm	3~400 V	2,5 A	1,1 kW	58 dB(A)	-30 / 80 °C	-30 / 60 °C	86,0 kg	436025646
HB-4-63A-075T	1 200 m ³ /h	1 800 Pa	1 430 rpm	3~400 V	2,1 A	0,75 kW	64 dB(A)	-30 / 80 °C	-30 / 40 °C	100,0 kg	436026340
HB-4-63A-110T	1 930 m ³ /h	1 800 Pa	1 430 rpm	3~400 V	2,5 A	1,1 kW	65 dB(A)	-30 / 80 °C	-30 / 40 °C	107,0 kg	436026341
HB-4-63A-150T	2 590 m ³ /h	1 800 Pa	1 440 rpm	3~400 V	3,6 A	1,5 kW	62 dB(A)	-30 / 80 °C	-30 / 40 °C	117,0 kg	436026342
HB-4-63B-075T	1 100 m ³ /h	1 900 Pa	1 430 rpm	3~400 V	2,1 A	0,75 kW	66 dB(A)	-30 / 80 °C	-30 / 60 °C	100,0 kg	436026343
HB-4-63B-110T	1 750 m ³ /h	1 900 Pa	1 430 rpm	3~400 V	2,5 A	1,1 kW	67 dB(A)	-30 / 80 °C	-30 / 60 °C	107,0 kg	436026344
HB-4-63B-150T	2 675 m ³ /h	1 900 Pa	1 440 rpm	3~400 V	3,6 A	1,5 kW	65 dB(A)	-30 / 80 °C	-30 / 40 °C	117,0 kg	436026345
HB-4-71A-150T	1 900 m ³ /h	2 300 Pa	1 440 rpm	3~400 V	3,6 A	1,5 kW	68 dB(A)	-30 / 80 °C	-30 / 40 °C	138,0 kg	436027140
HB-4-71A-220T	3 150 m ³ /h	2 300 Pa	1 465 rpm	3~400 V	4,6 A	2,2 kW	68 dB(A)	-30 / 80 °C	-30 / 40 °C	138,0 kg	436027141
HB-4-71A-300T	3 700 m ³ /h	2 300 Pa	1 460 rpm	3~400 V	6,7 A	3,0 kW	66 dB(A)	-30 / 80 °C	-30 / 40 °C	141,0 kg	436027142
HB-4-71B-110T	1 100 m ³ /h	2 360 Pa	1 430 rpm	3~400 V	2,5 A	1,1 kW	69 dB(A)	-30 / 80 °C	-30 / 60 °C	128,0 kg	436027143
HB-4-71B-150T	1 800 m ³ /h	2 400 Pa	1 440 rpm	3~400 V	3,6 A	1,5 kW	70 dB(A)	-30 / 80 °C	-30 / 40 °C	138,0 kg	436027144
HB-4-71B-220T	2 950 m ³ /h	2 400 Pa	1 465 rpm	3~400 V	4,6 A	2,2 kW	71 dB(A)	-30 / 80 °C	-30 / 40 °C	138,0 kg	436027145
HB-4-71B-300T	4 250 m ³ /h	2 400 Pa	1 460 rpm	3~400 V	6,7 A	3,0 kW	67 dB(A)	-30 / 80 °C	-30 / 40 °C	141,0 kg	436027146
HB-4-80A-220T	1 950 m ³ /h	2 900 Pa	1 465 rpm	3~400 V	4,6 A	2,2 kW	72 dB(A)	-30 / 80 °C	-30 / 40 °C	162,0 kg	436028040
HB-4-80A-300T	3 200 m ³ /h	2 900 Pa	1 460 rpm	3~400 V	6,7 A	3,0 kW	73 dB(A)	-30 / 80 °C	-30 / 40 °C	165,0 kg	436028041
HB-4-80A-400T	4 500 m ³ /h	2 900 Pa	1 460 rpm	3~400 V	8,1 A	4,0 kW	71 dB(A)	-30 / 80 °C	-30 / 40 °C	176,0 kg	436028042
HB-4-80A-550T	5 270 m ³ /h	2 900 Pa	1 460 rpm	3~400 V	10,9 A	5,5 kW	67 dB(A)	-30 / 80 °C	-30 / 40 °C	197,0 kg	436028043
HB-4-80B-300T	2 700 m ³ /h	3 060 Pa	1 460 rpm	3~400 V	6,7 A	3,0 kW	73 dB(A)	-30 / 80 °C	-30 / 40 °C	165,0 kg	436028044
HB-4-80B-400T	4 200 m ³ /h	3 060 Pa	1 460 rpm	3~400 V	8,1 A	4,0 kW	74 dB(A)	-30 / 80 °C	-30 / 40 °C	176,0 kg	436028045
HB-4-80B-550T	6 050 m ³ /h	3 060 Pa	1 460 rpm	3~400 V	10,9 A	5,5 kW	68 dB(A)	-30 / 80 °C	-30 / 40 °C	197,0 kg	436028046
HB-4-90A-400T	3 000 m ³ /h	3 680 Pa	1 460 rpm	3~400 V	8,1 A	4,0 kW	76 dB(A)	-30 / 80 °C	-30 / 40 °C	225,0 kg	436029040
HB-4-90A-550T	4 600 m ³ /h	3 680 Pa	1 460 rpm	3~400 V	10,9 A	5,5 kW	76 dB(A)	-30 / 80 °C	-30 / 40 °C	247,0 kg	436029041
HB-4-90A-750T	6 800 m ³ /h	3 680 Pa	1 465 rpm	3~400 V	14,4 A	7,5 kW	75 dB(A)	-30 / 80 °C	-30 / 40 °C	251,0 kg	436029042
HB-4-90A-1100T	7 500 m ³ /h	3 680 Pa	1 475 rpm	3~400 V	20,9 A	11,0 kW	71 dB(A)	-30 / 80 °C	-30 / 40 °C	320,0 kg	436029043
HB-4-90B-400T	2 600 m ³ /h	3 870 Pa	1 460 rpm	3~400 V	8,1 A	4,0 kW	77 dB(A)	-30 / 80 °C	-30 / 40 °C	225,0 kg	436029044
HB-4-90B-550T	4 400 m ³ /h	3 870 Pa	1 460 rpm	3~400 V	10,9 A	5,5 kW	76 dB(A)	-30 / 80 °C	-30 / 40 °C	247,0 kg	436029045
HB-4-90B-750T	6 300 m ³ /h	3 870 Pa	1 465 rpm	3~400 V	14,4 A	7,5 kW	75 dB(A)	-30 / 80 °C	-30 / 40 °C	251,0 kg	436029046
HB-4-90B-1100T	8 660 m ³ /h	3 870 Pa	1 475 rpm	3~400 V	20,9 A	11,0 kW	71 dB(A)	-30 / 80 °C	-30 / 40 °C	320,0 kg	436029047
HB-4-100A-750T	4 800 m ³ /h	4 500 Pa	1 465 rpm	3~400 V	14,4 A	7,5 kW	79 dB(A)	-30 / 80 °C	-30 / 40 °C	279,0 kg	436021040
HB-4-100A-1100T	7 700 m ³ /h	4 500 Pa	1 475 rpm	3~400 V	20,9 A	11,0 kW	80 dB(A)	-30 / 80 °C	-30 / 40 °C	348,0 kg	436021041
HB-4-100A-1500T	10 300 m ³ /h	4 500 Pa	1 475 rpm	3~400 V	28,1 A	15,0 kW	76 dB(A)	-30 / 80 °C	-30 / 40 °C	366,0 kg	436021042
HB-4-100B-750T	4 300 m ³ /h	4 780 Pa	1 465 rpm	3~400 V	14,4 A	7,5 kW	80 dB(A)	-30 / 80 °C	-30 / 40 °C	279,0 kg	436021043
HB-4-100B-1100T	6 900 m ³ /h	4 780 Pa	1 475 rpm	3~400 V	20,9 A	11,0 kW	81 dB(A)	-30 / 80 °C	-30 / 40 °C	348,0 kg	436021044
HB-4-100B-1500T	10 580 m ³ /h	4 780 Pa	1 475 rpm	3~400 V	28,1 A	15,0 kW	78 dB(A)	-30 / 80 °C	-30 / 40 °C	366,0 kg	436021045

*pomiar wykonany w odległości 1,5m od wylotu, dla Q = 2/3*Qmax

** wartość prądu znamionowego może się różnić w zależności od producenta zastosowanego silnika elektrycznego.



CHARAKTERYSTYKI PRACY WENTYLATORÓW - Silniki dwubiegunowe 40-56

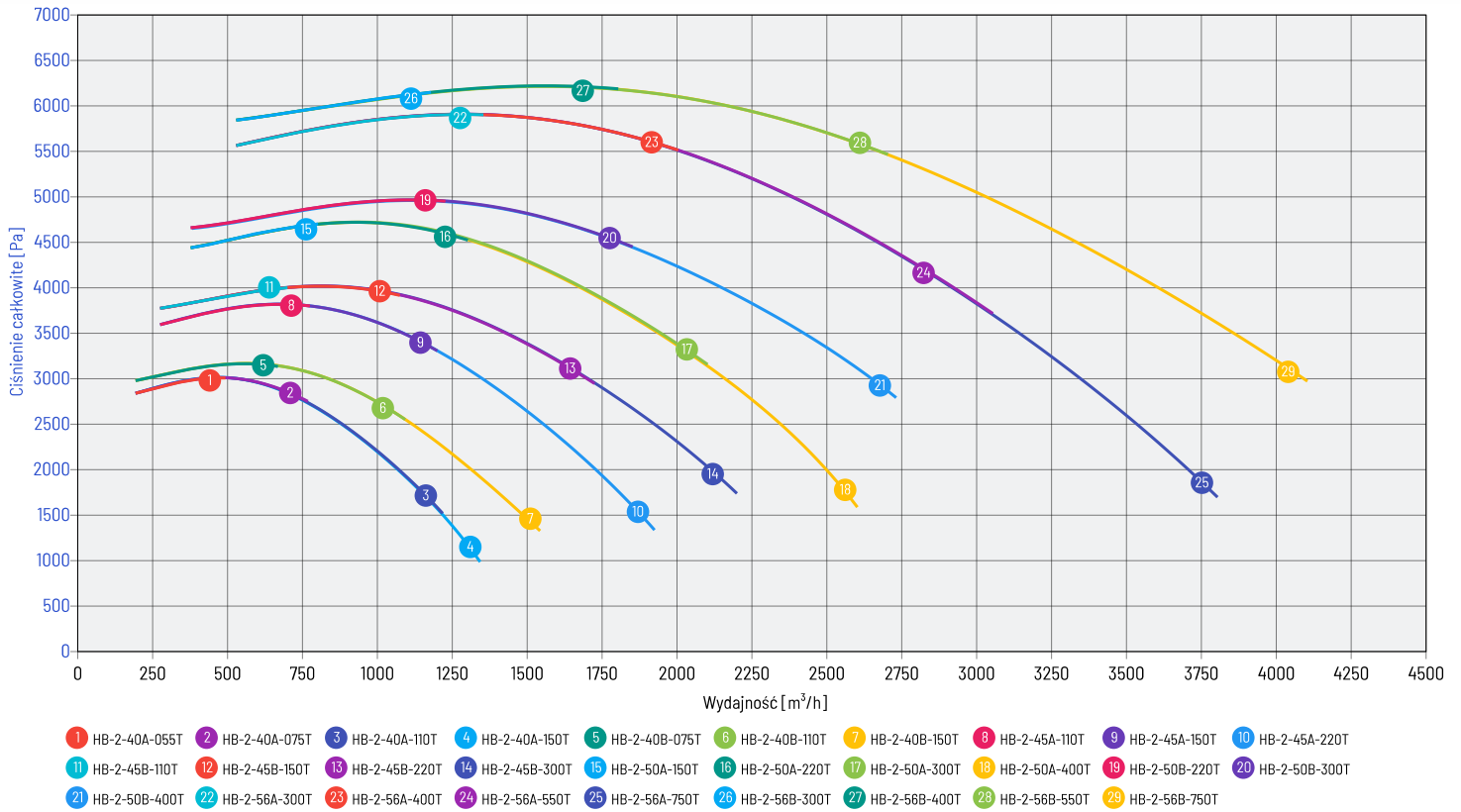

CHARAKTERYSTYKI PRACY WENTYLATORÓW - Silniki dwubiegunowe 63-100

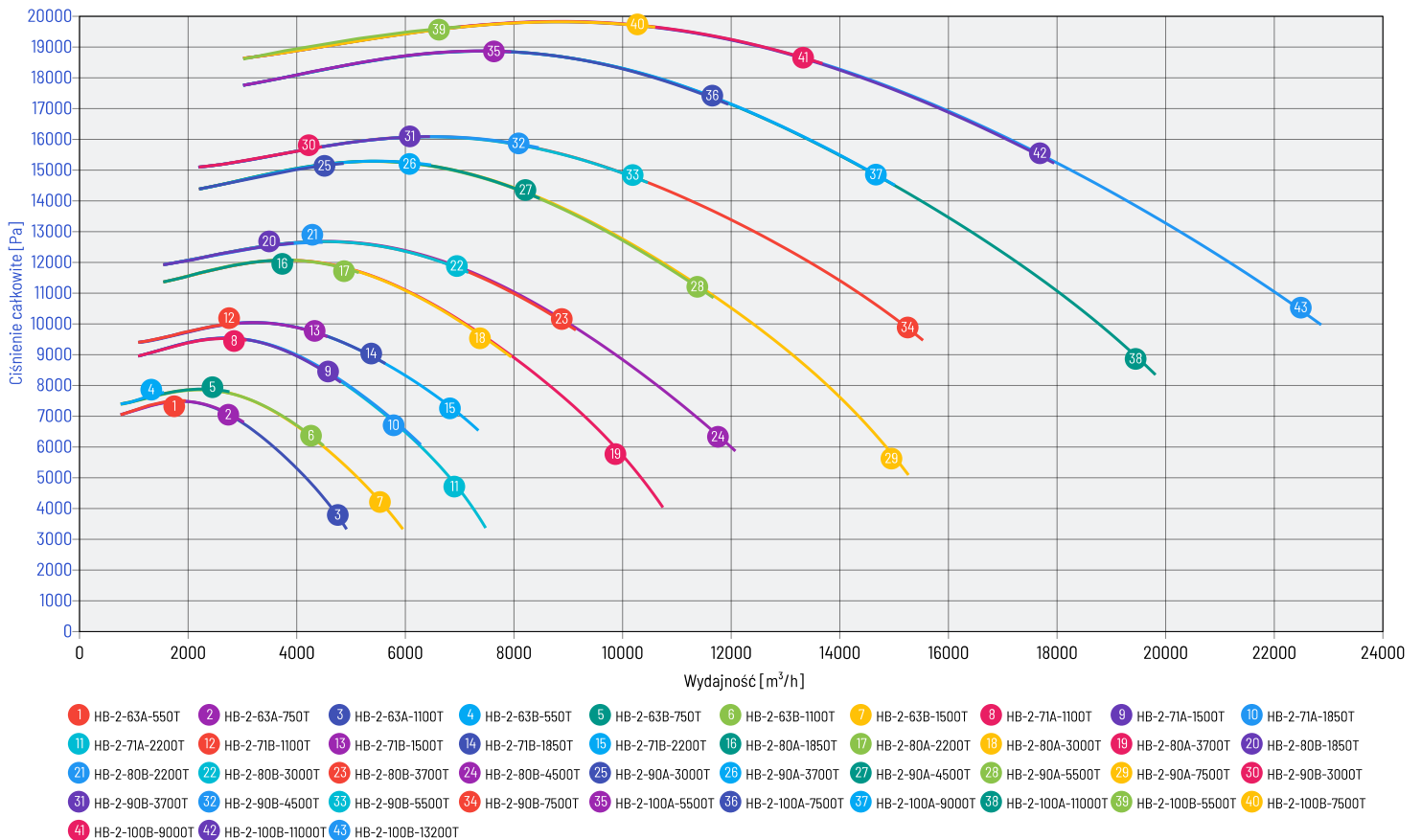



CHARAKTERYSTYKI PRACY WENTYLATORÓW - Silniki czterobiegunowe 40-56

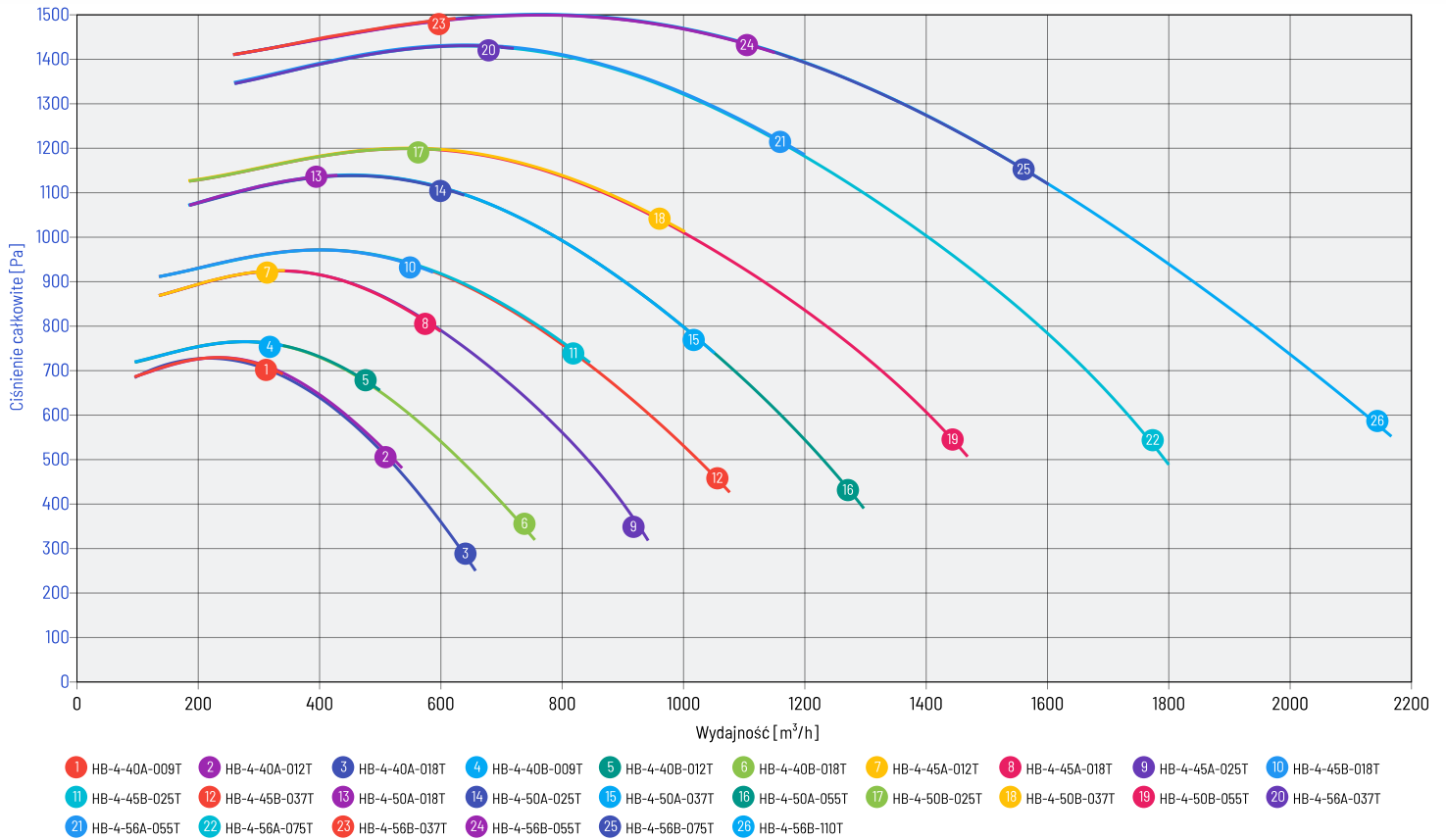

CHARAKTERYSTYKI PRACY WENTYLATORÓW - Silniki czterobiegunowe 63-100

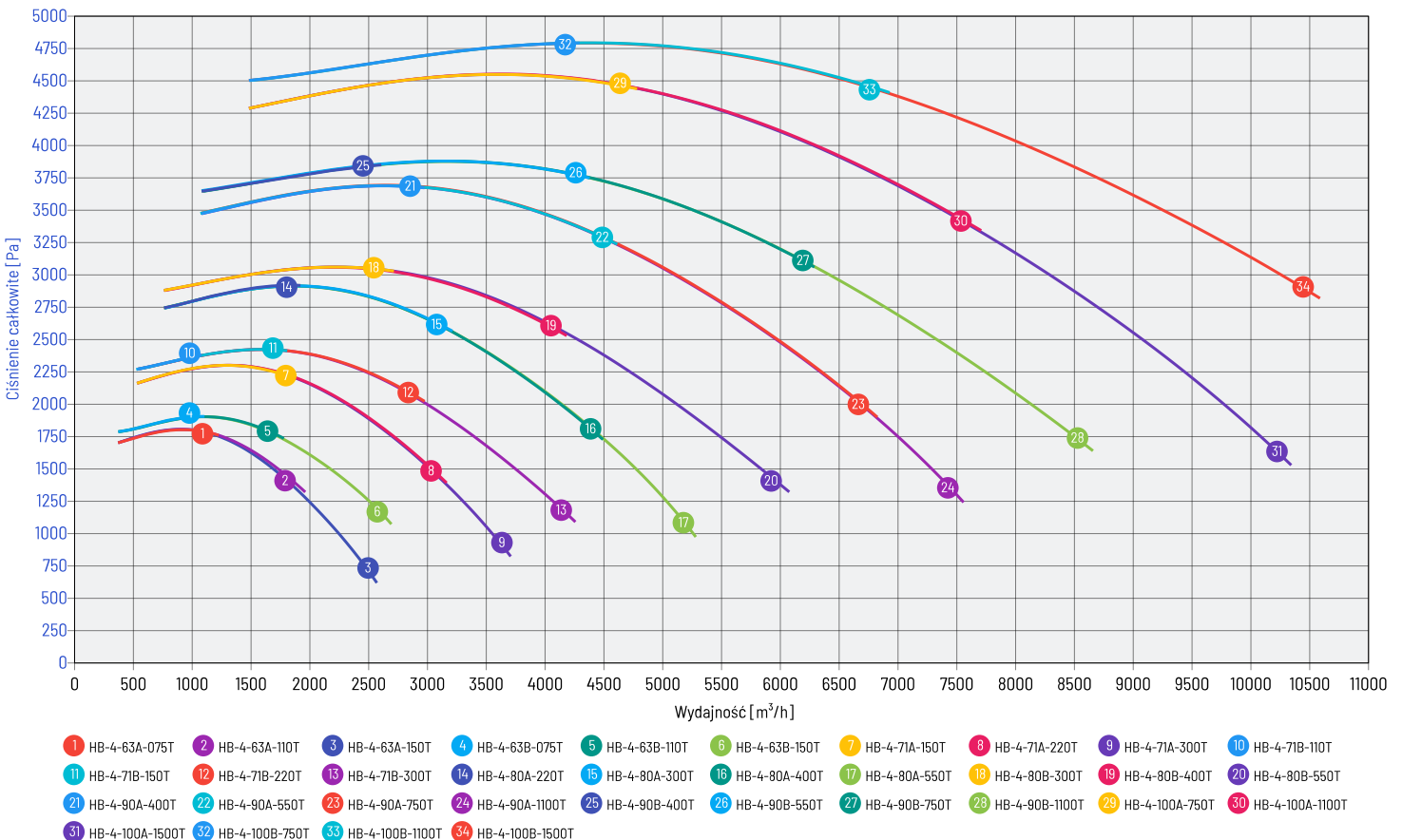



CHARAKTERYSTYKI PRACY

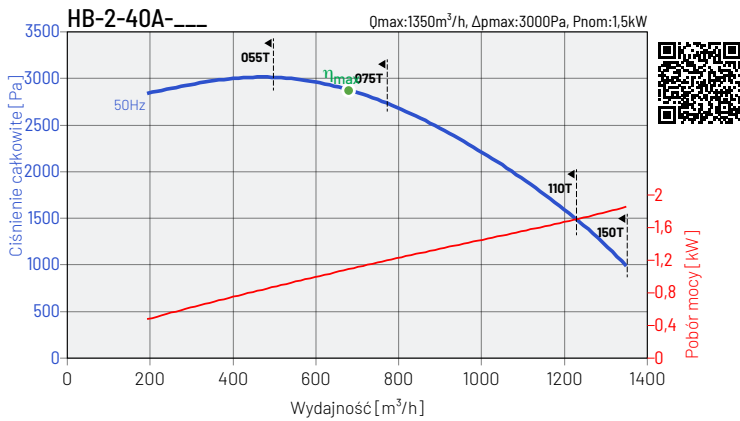

	MC	EC	SR	VSD	η %	N	kW	m ³ /h	Pa	rpm
055T	C	statyczna	1	nie	52,7	64,6	0,74	488	2 880	2 790
075T	C	statyczna	1	nie	57,3	68,5	0,86	670	2 647	2 890
110T	C	statyczna	1	nie	58,0	69,3	0,85	670	2 647	2 890
150T	C	statyczna	1	nie	58,9	70,2	0,84	670	2 647	2 880

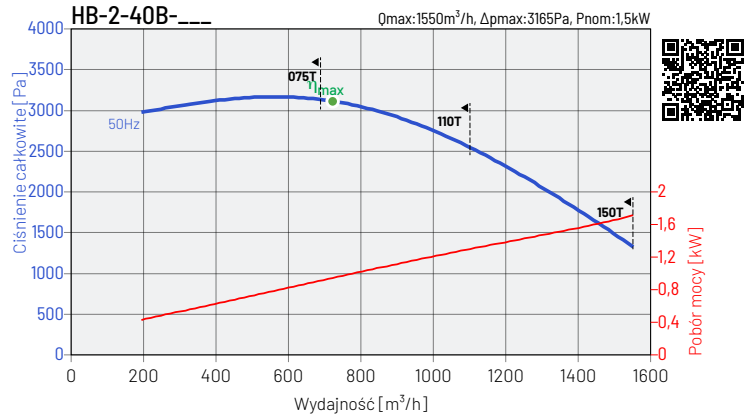

	MC	EC	SR	VSD	η %	N	kW	m ³ /h	Pa	rpm
075T	C	statyczna	1	nie	62,4	73,1	0,95	707	3 031	2 890
110T	C	statyczna	1	nie	63,1	73,9	0,94	707	3 031	2 890
150T	C	statyczna	1	nie	64,1	74,9	0,93	707	3 031	2 880

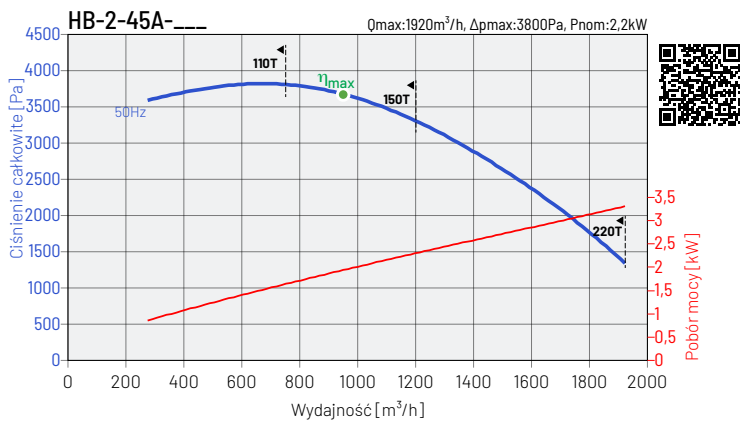

	MC	EC	SR	VSD	η %	N	kW	m ³ /h	Pa	rpm
110T	C	statyczna	1	nie	57,7	66,9	1,33	763	3 607	2 890
150T	C	statyczna	1	nie	58,8	67,4	1,51	954	3 347	2 925
220T	C	statyczna	1	nie	60,0	68,7	1,48	954	3 347	2 910

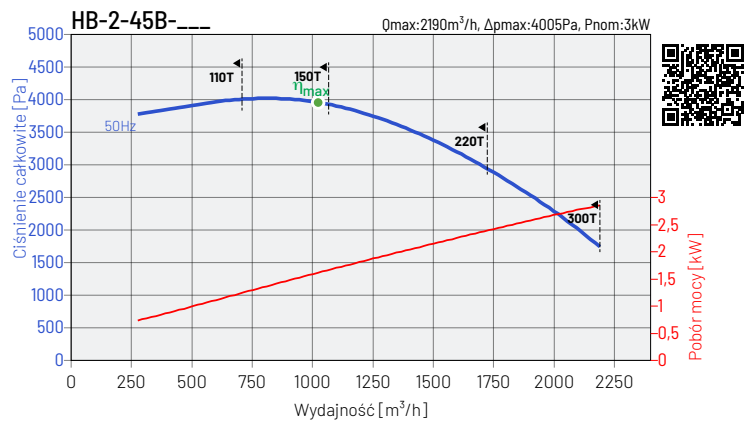

	MC	EC	SR	VSD	η %	N	kW	m ³ /h	Pa	rpm
110T	C	statyczna	1	nie	59,3	68,4	1,33	715	3 947	2 890
150T	C	statyczna	1	nie	64,1	72,3	1,68	1 006	3 844	2 925
220T	C	statyczna	1	nie	65,4	73,7	1,64	1 006	3 844	2 910
300T	C	statyczna	1	nie	66,3	74,7	1,62	1 006	3 844	2 880

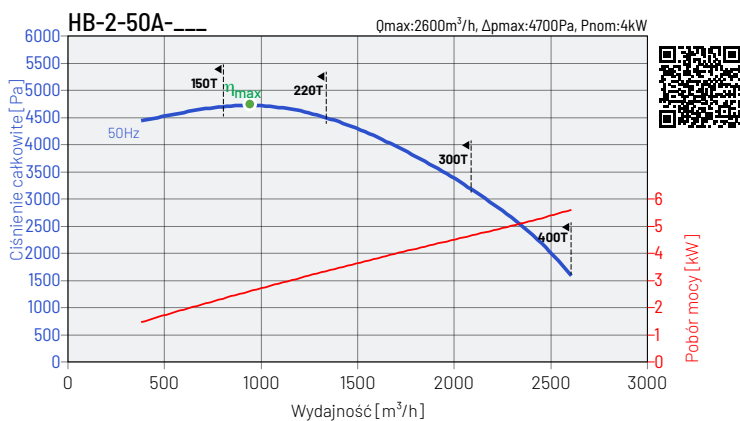

	MC	EC	SR	VSD	η %	N	kW	m ³ /h	Pa	rpm
150T	C	statyczna	1	nie	58,6	66,5	1,78	801	4 691	2 925
220T	C	statyczna	1	nie	60,4	67,8	1,97	954	4 498	2 910
300T	C	statyczna	1	nie	61,1	68,6	1,95	954	4 498	2 915
400T	C	statyczna	1	nie	61,9	69,4	1,93	954	4 498	2 895

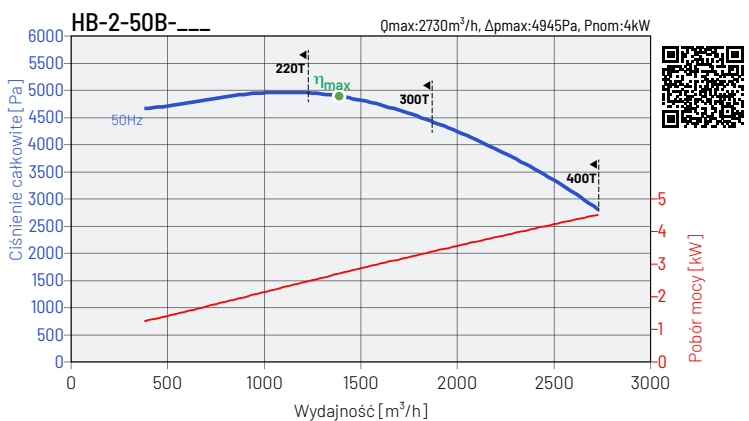

	MC	EC	SR	VSD	η %	N	kW	m ³ /h	Pa	rpm
220T	C	statyczna	1	nie	61,0	67,9	2,18	981	4 876	2 910
300T	C	statyczna	1	nie	66,4	72,3	2,74	1 380	4 752	2 915
400T	C	statyczna	1	nie	67,5	73,5	2,70	1 380	4 752	2 895

Charakterystyki pracy wentylatorów wyznaczone dla medium o temperaturze 20°C. Poziom ciśnienia akustycznego dB(A), wyznaczony w odległości 1,5m.



CHARAKTERYSTYKI PRACY

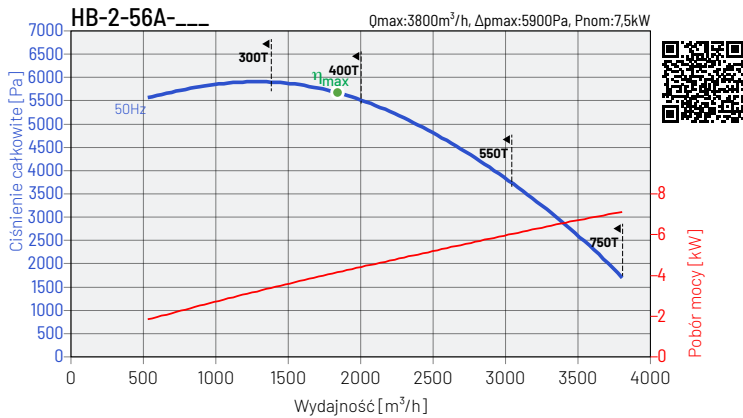

	MC	EC	SR	VSD	η %	N	kW	m ³ /h	Pa	rpm
300T	C	statyczna	1	nie	61,7	66,6	3,43	1340	5 697	2 915
400T	C	statyczna	1	nie	62,7	67,4	4,30	1838	5 288	2 895
550T	C	statyczna	1	nie	63,5	68,2	4,25	1838	5 288	2 940
750T	C	statyczna	1	nie	64,2	68,9	4,21	1838	5 288	2 930

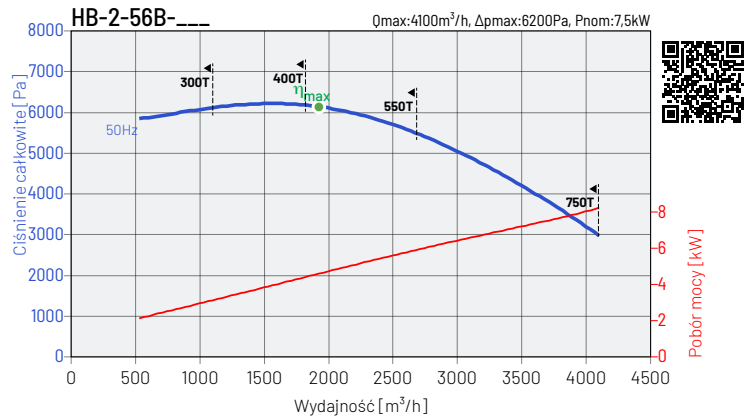

	MC	EC	SR	VSD	η %	N	kW	m ³ /h	Pa	rpm
300T	C	statyczna	1	nie	64,2	67,9	4,48	1 719	6 023	2 895
400T	C	statyczna	1	nie	64,2	67,9	4,48	1 719	6 023	2 895
550T	C	statyczna	1	nie	68,0	71,4	4,72	1 939	5 956	2 940
750T	C	statyczna	1	nie	69,4	72,9	4,63	1 939	5 956	2 930

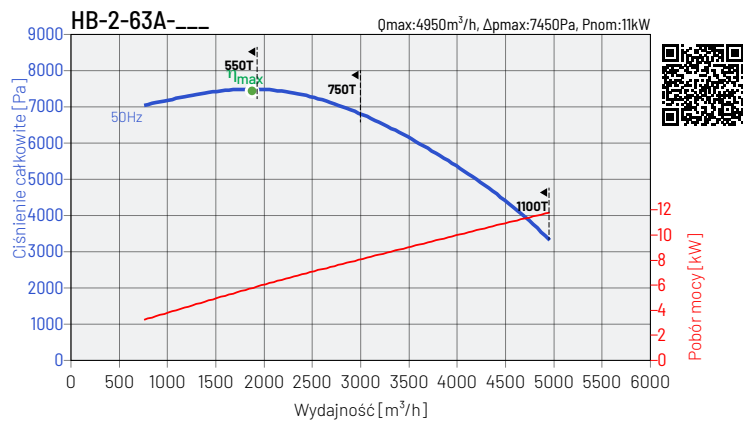

	MC	EC	SR	VSD	η %	N	kW	m ³ /h	Pa	rpm
550T	C	statyczna	1	nie	62,6	64,9	6,04	1 907	7 140	2 940
750T	C	statyczna	1	nie	63,2	65,6	5,98	1 907	7 140	2 930
1100T	C	statyczna	1	nie	64,0	66,4	5,91	1 907	7 140	2 925

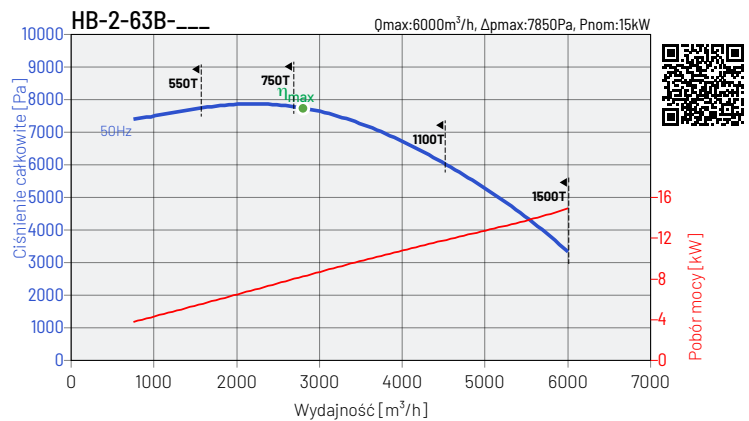

	MC	EC	SR	VSD	η %	N	kW	m ³ /h	Pa	rpm
550T	C	statyczna	1	nie	63,8	66,0	6,17	1 843	7 686	2 940
750T	C	statyczna	1	nie	68,9	69,7	8,32	2 722	7 586	2 930
1100T	C	statyczna	1	nie	69,5	70,4	8,32	2 761	7 538	2 925
1500T	C	statyczna	1	nie	70,9	71,8	8,16	2 761	7 538	2 940

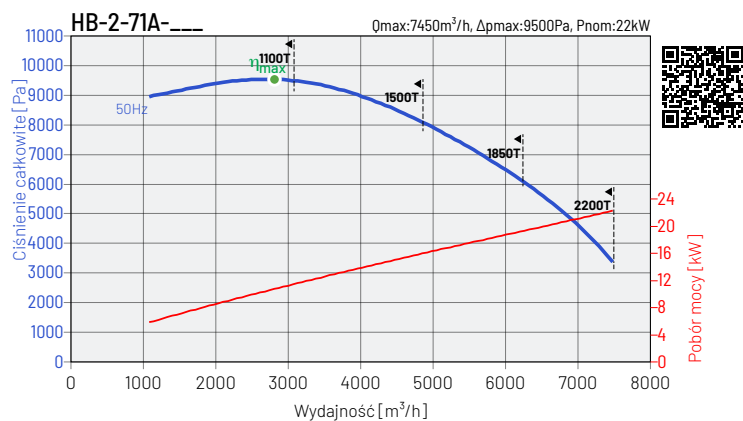

	MC	EC	SR	VSD	η %	N	kW	m ³ /h	Pa	rpm
1100T	C	statyczna	1	nie	64,5	64,5	10,66	2 730	9 072	2 940
1500T	C	statyczna	1	nie	64,5	64,5	10,66	2 730	9 072	2 940
1850T	C	statyczna	1	nie	64,9	64,9	10,60	2 730	9 072	2 940
2200T	C	statyczna	1	nie	65,1	65,1	10,57	2 730	9 072	2 950

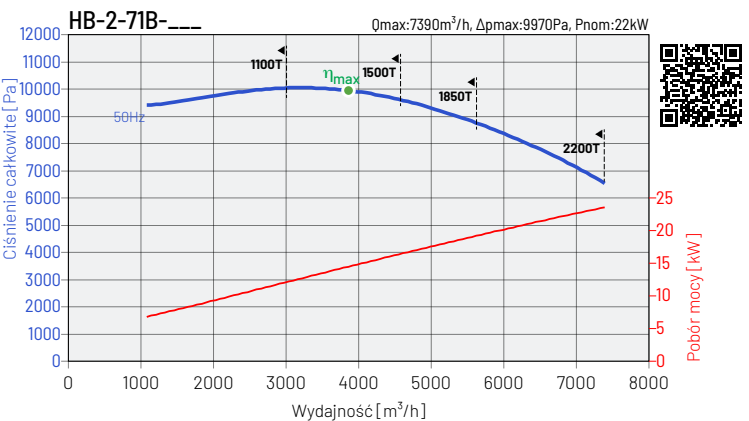

	MC	EC	SR	VSD	η %	N	kW	m ³ /h	Pa	rpm
1100T	C	statyczna	1	nie	64,2	64,0	12,06	2 910	9 573	2 925
1500T	C	statyczna	1	nie	69,9	69,5	15,00	3 952	9 557	2 940
1850T	C	statyczna	1	nie	70,3	69,9	14,92	3 952	9 557	2 940
2200T	C	statyczna	1	nie	71,2	70,9	14,73	3 952	9 557	2 950

Charakterystyki pracy wentylatorów wyznaczone dla medium o temperaturze 20°C. Poziom ciśnienia akustycznego dB(A), wyznaczony w odległości 1,5m.



CHARAKTERYSTYKI PRACY

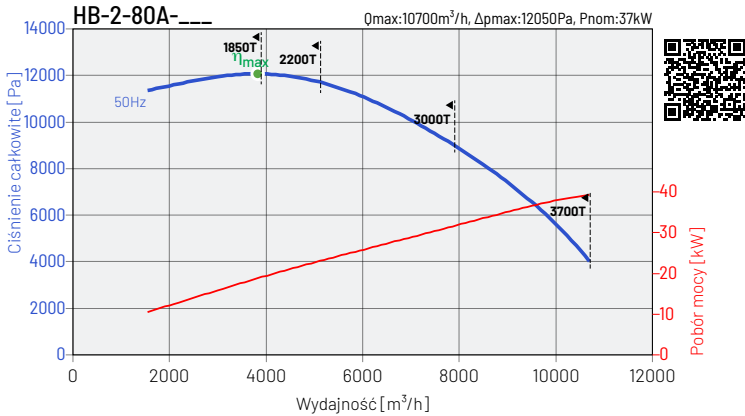

	MC	EC	SR	VSD	$\eta\%$	N	kW	m^3/h	Pa	rpm
1850T	C	statyczna	1	nie	64,8	64,2	19,26	3 906	11 511	2 940
2200T	C	statyczna	1	nie	65,1	64,4	19,20	3 906	11 511	2 950
3000T	C	statyczna	1	nie	65,6	65,0	19,03	3 906	11 511	2 965
3700T	C	statyczna	1	nie	65,8	65,1	18,99	3 906	11 511	2 955

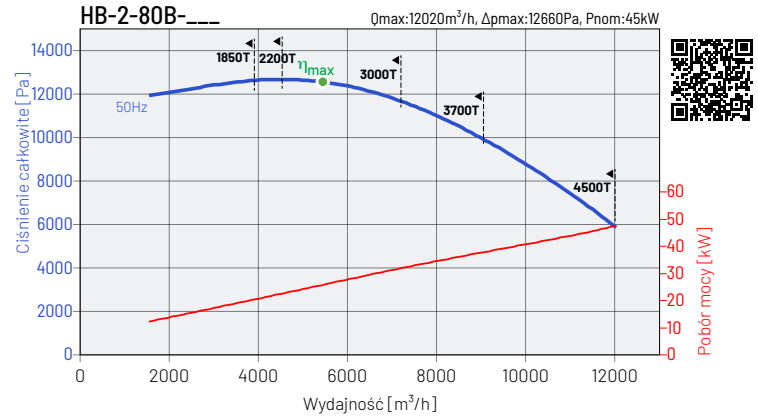

	MC	EC	SR	VSD	$\eta\%$	N	kW	m^3/h	Pa	rpm
1850T	C	statyczna	1	nie	71,1	70,1	26,78	5 653	12 125	2 965
2200T	C	statyczna	1	nie	71,1	70,1	26,78	5 653	12 125	2 965
3000T	C	statyczna	1	nie	71,1	70,1	26,78	5 653	12 125	2 965
3700T	C	statyczna	1	nie	71,2	70,2	26,73	5 653	12 125	2 955
4500T	C	statyczna	1	nie	71,7	70,7	26,56	5 653	12 125	2 960

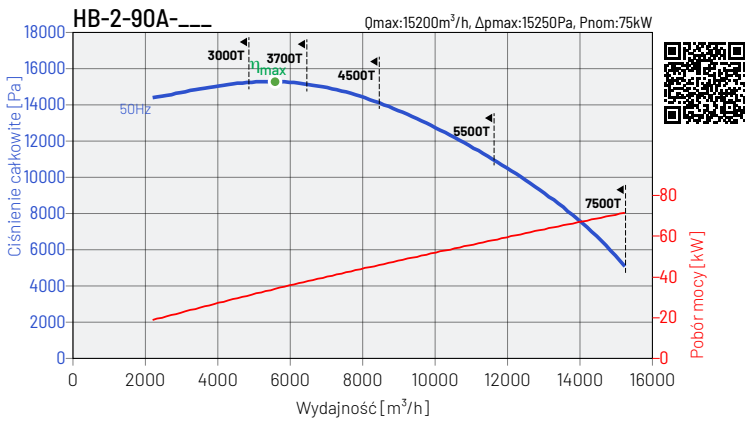

	MC	EC	SR	VSD	$\eta\%$	N	kW	m^3/h	Pa	rpm
3000T	C	statyczna	1	nie	65,8	64,5	34,22	5 561	14 576	2 955
3700T	C	statyczna	1	nie	65,8	64,5	34,22	5 561	14 576	2 955
4500T	C	statyczna	1	nie	66,1	64,9	34,04	5 561	14 576	2 960
5500T	C	statyczna	1	nie	66,4	65,1	33,93	5 561	14 576	2 970
7500T	C	statyczna	1	nie	66,5	65,2	33,86	5 561	14 576	2 960

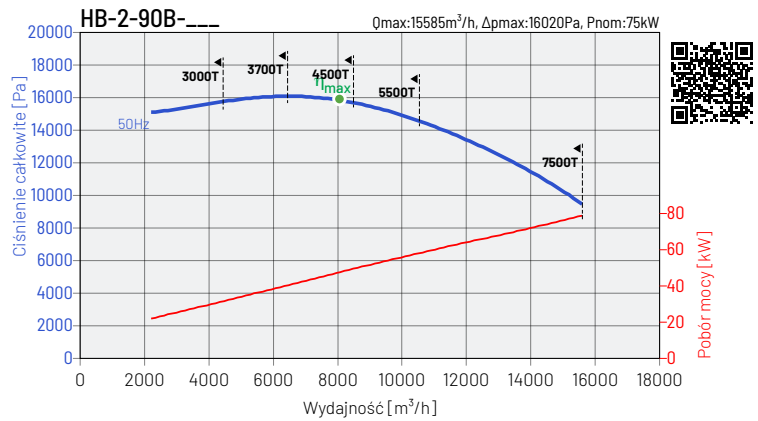

	MC	EC	SR	VSD	$\eta\%$	N	kW	m^3/h	Pa	rpm
3000T	C	statyczna	1	nie	71,8	70,4	39,49	6 413	15 921	2 955
3700T	C	statyczna	1	nie	71,8	70,4	39,49	6 413	15 921	2 955
4500T	C	statyczna	1	nie	71,8	70,2	47,91	8 049	15 839	2 960
5500T	C	statyczna	1	nie	72,0	70,4	47,76	8 049	15 839	2 970
7500T	C	statyczna	1	nie	72,4	70,8	47,50	8 049	15 839	2 960

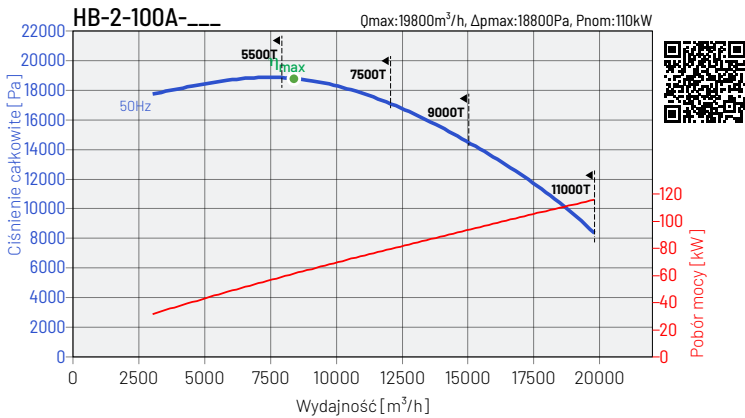

	MC	EC	SR	VSD	$\eta\%$	N	kW	m^3/h	Pa	rpm
5500T	C	statyczna	1	nie	66,3	64,5	57,47	7 628	17 993	2 970
7500T	C	statyczna	1	nie	66,5	64,6	57,35	7 628	17 993	2 960
9000T	C	statyczna	1	nie	66,7	64,8	57,16	7 628	17 993	2 980
11000T	C	statyczna	1	nie	66,8	65,0	57,04	7 628	17 993	2 980

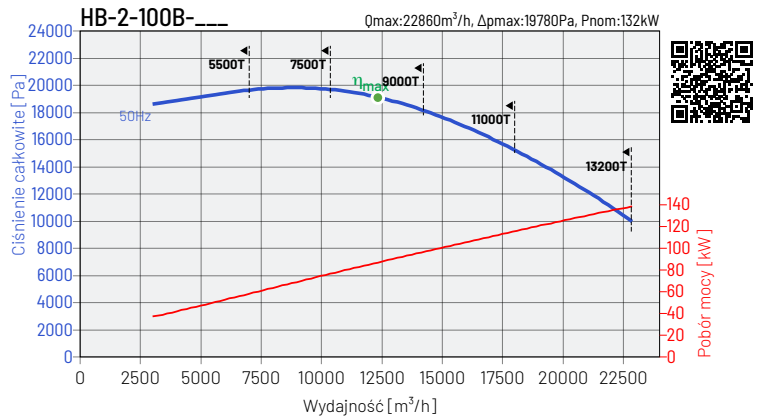

	MC	EC	SR	VSD	$\eta\%$	N	kW	m^3/h	Pa	rpm
5500T	C	statyczna	1	nie	66,9	65,1	58,08	7 069	19 798	2 970
7500T	C	statyczna	1	nie	74,0	71,8	79,20	10 657	19 786	2 960
9000T	C	statyczna	1	nie	74,5	72,3	80,45	11 041	19 555	2 980
11000T	C	statyczna	1	nie	74,7	72,5	80,28	11 041	19 555	2 980
13200T	C	statyczna	1	nie	74,9	72,6	80,11	11 041	19 555	2 975

Charakterystyki pracy wentylatorów wyznaczone dla medium o temperaturze 20°C. Poziom ciśnienia akustycznego dB(A), wyznaczony w odległości 1,5m.



CHARAKTERYSTYKI PRACY

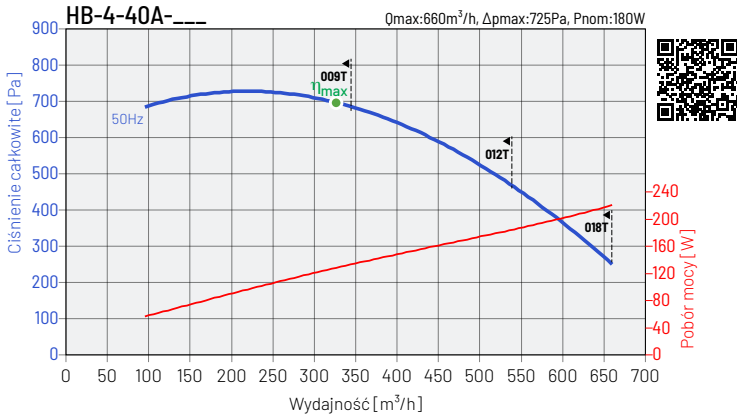

	MC	EC	SR	VSD	η %	N	kW	m ³ /h	Pa	rpm
009T	C	statyczna	1	nie	45,3	65,2	0,13	329	640	1380
012T	C	statyczna	1	nie	45,3	65,2	0,13	329	640	1380
018T	C	statyczna	1	nie	45,3	65,2	0,13	329	640	1380

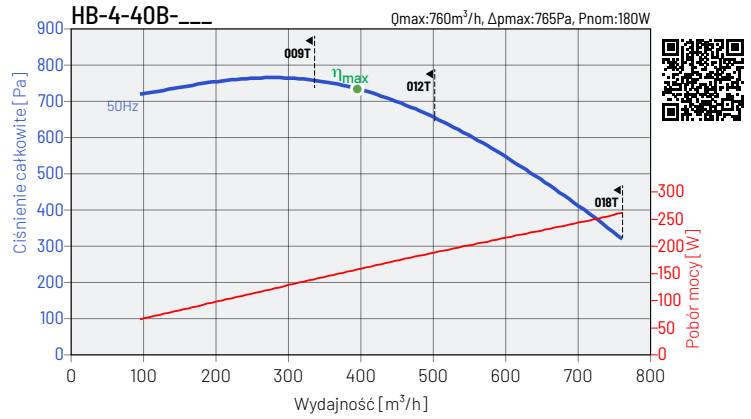

	MC	EC	SR	VSD	η %	N	kW	m ³ /h	Pa	rpm
009T	C	statyczna	1	nie	48,0	67,2	0,15	340	763	1380
012T	C	statyczna	1	nie	47,0	66,0	0,16	347	732	1380
018T	C	statyczna	1	nie	51,0	70,3	0,14	347	732	1380

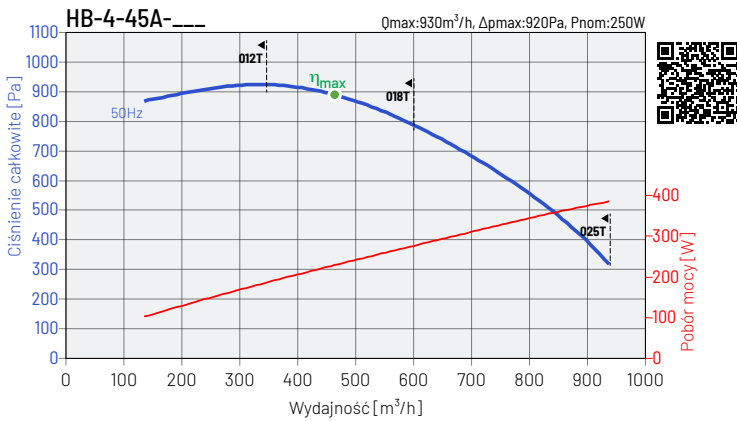

	MC	EC	SR	VSD	η %	N	kW	m ³ /h	Pa	rpm
012T	C	statyczna	1	nie	46,0	63,2	0,23	469	809	1380
018T	C	statyczna	1	nie	46,0	63,2	0,23	469	809	1380
025T	C	statyczna	1	nie	46,0	63,2	0,23	469	809	1380

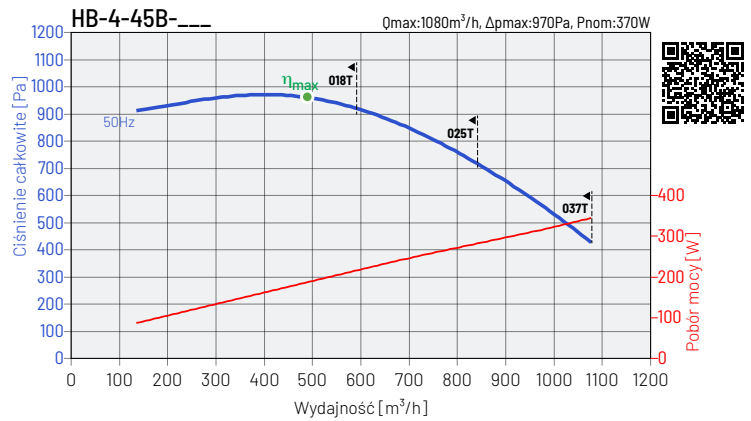

	MC	EC	SR	VSD	η %	N	kW	m ³ /h	Pa	rpm
018T	C	statyczna	1	nie	51,0	67,7	0,26	495	957	1380
025T	C	statyczna	1	nie	51,8	68,6	0,25	495	957	1380
037T	C	statyczna	1	nie	55,1	72,1	0,24	495	957	1370

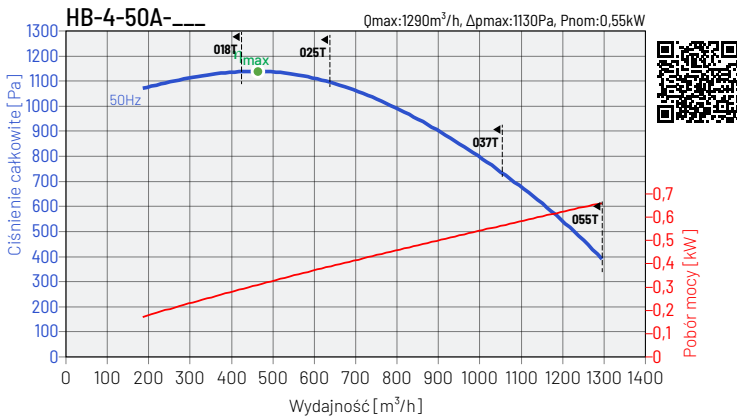

	MC	EC	SR	VSD	η %	N	kW	m ³ /h	Pa	rpm
018T	C	statyczna	1	nie	49,1	65,3	0,29	469	1087	1370
025T	C	statyczna	1	nie	49,1	65,3	0,29	469	1087	1370
037T	C	statyczna	1	nie	49,1	65,3	0,29	469	1087	1370
055T	C	statyczna	1	nie	54,1	70,7	0,26	469	1087	1400

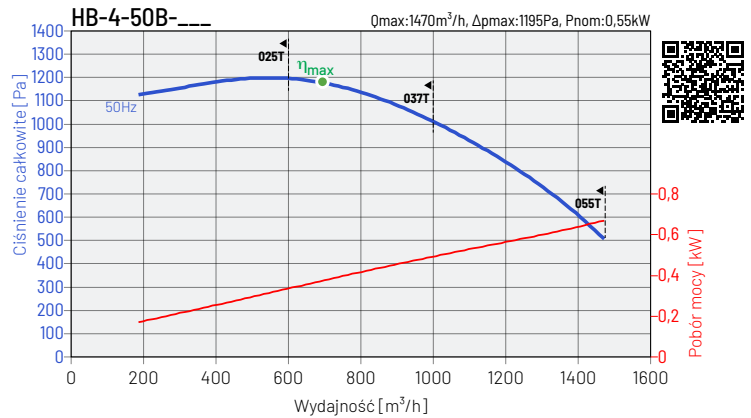

	MC	EC	SR	VSD	η %	N	kW	m ³ /h	Pa	rpm
025T	C	statyczna	1	nie	53,1	68,0	0,38	603	1201	1380
037T	C	statyczna	1	nie	54,9	69,5	0,41	678	1181	1370
055T	C	statyczna	1	nie	60,4	75,5	0,37	678	1181	1400

Charakterystyki pracy wentylatorów wyznaczone dla medium o temperaturze 20°C. Poziom ciśnienia akustycznego dB(A), wyznaczony w odległości 1,5m.



CHARAKTERYSTYKI PRACY

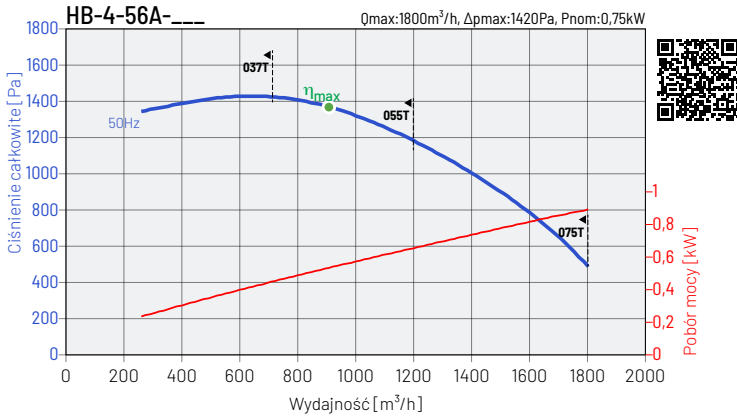

	MC	EC	SR	VSD	η %	N	kW	m ³ /h	Pa	rpm
037T	C	statyczna	1	nie	54,9	67,9	0,58	904	1277	1400
055T	C	statyczna	1	nie	54,9	67,9	0,58	904	1277	1400
075T	C	statyczna	1	nie	58,7	72,0	0,55	904	1277	1430

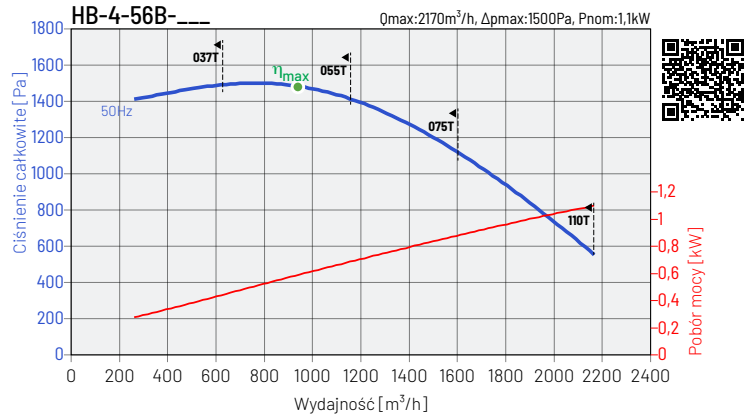

	MC	EC	SR	VSD	η %	N	kW	m ³ /h	Pa	rpm
037T	C	statyczna	1	nie	59,0	73,3	0,44	622	1503	1370
055T	C	statyczna	1	nie	60,5	73,0	0,65	953	1482	1400
075T	C	statyczna	1	nie	64,7	77,5	0,61	953	1482	1430
110T	C	statyczna	1	nie	66,0	78,9	0,59	953	1482	1430

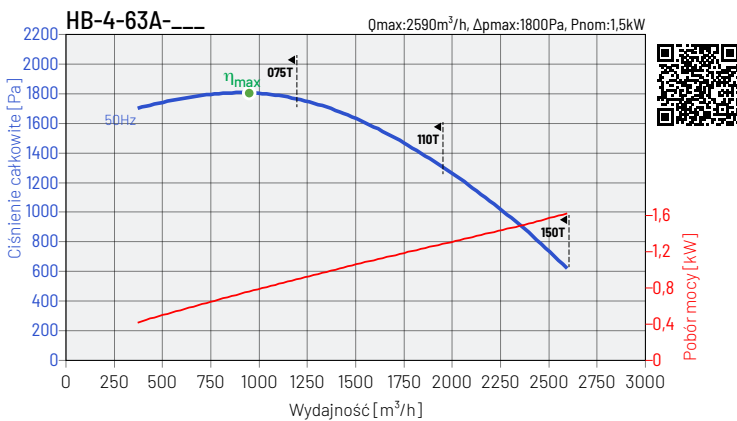

	MC	EC	SR	VSD	η %	N	kW	m ³ /h	Pa	rpm
075T	C	statyczna	1	nie	57,9	69,6	0,78	938	1725	1430
110T	C	statyczna	1	nie	59,0	70,8	0,76	938	1725	1430
150T	C	statyczna	1	nie	59,9	71,7	0,75	938	1725	1440

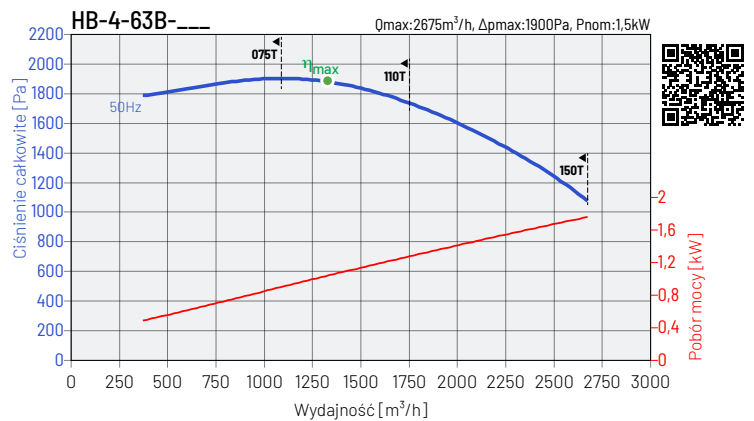

	MC	EC	SR	VSD	η %	N	kW	m ³ /h	Pa	rpm
075T	C	statyczna	1	nie	63,4	74,4	0,91	1103	1882	1430
110T	C	statyczna	1	nie	66,0	76,2	1,07	1357	1875	1430
150T	C	statyczna	1	nie	66,9	77,2	1,06	1357	1875	1440

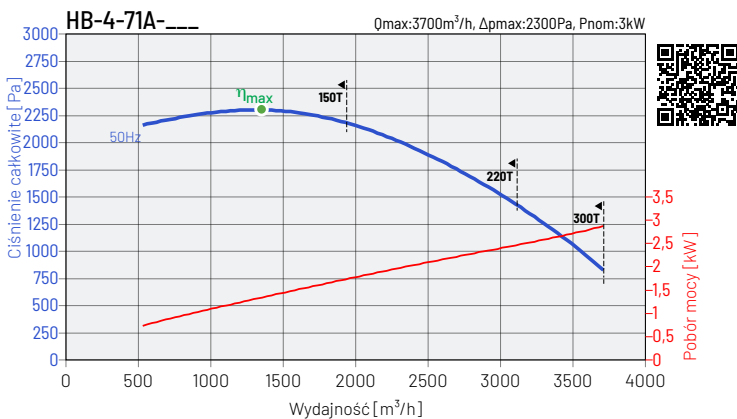

	MC	EC	SR	VSD	η %	N	kW	m ³ /h	Pa	rpm
150T	C	statyczna	1	nie	59,9	69,0	1,36	1342	2192	1440
220T	C	statyczna	1	nie	60,9	70,0	1,34	1342	2192	1465
300T	C	statyczna	1	nie	61,6	70,8	1,33	1342	2192	1460

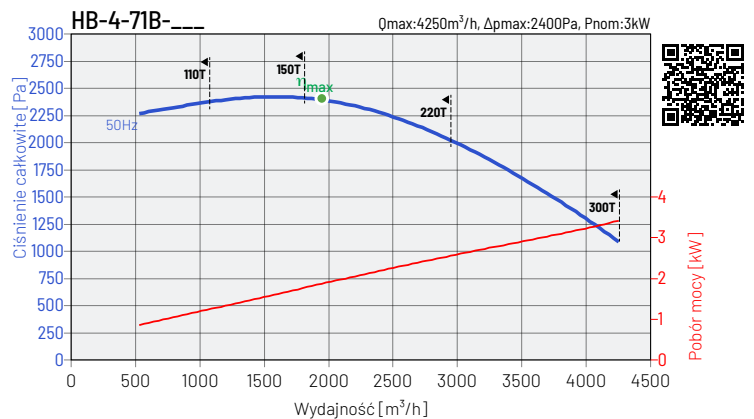

	MC	EC	SR	VSD	η %	N	kW	m ³ /h	Pa	rpm
110T	C	statyczna	1	nie	67,7	75,6	1,76	1794	2389	1440
150T	C	statyczna	1	nie	67,7	75,6	1,76	1794	2389	1440
220T	C	statyczna	1	nie	68,0	75,6	1,89	1942	2382	1465
300T	C	statyczna	1	nie	68,8	76,5	1,87	1942	2382	1460

Charakterystyki pracy wentylatorów wyznaczone dla medium o temperaturze 20°C. Poziom ciśnienia akustycznego dB(A), wyznaczony w odległości 1,5m.



CHARAKTERYSTYKI PRACY

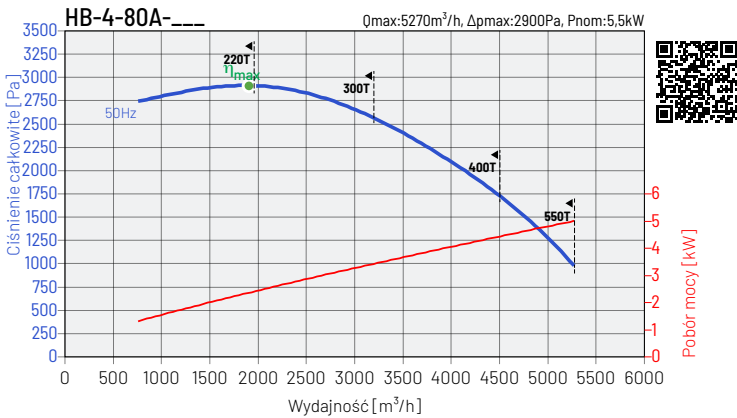

	MC	EC	SR	VSD	η %	N	kW	m ³ /h	Pa	rpm
220T	C	statyczna	1	nie	60,8	67,3	2,44	1920	2 781	1465
300T	C	statyczna	1	nie	61,5	68,0	2,41	1920	2 781	1460
400T	C	statyczna	1	nie	62,2	68,7	2,39	1920	2 781	1460
550T	C	statyczna	1	nie	62,9	69,5	2,36	1920	2 781	1460

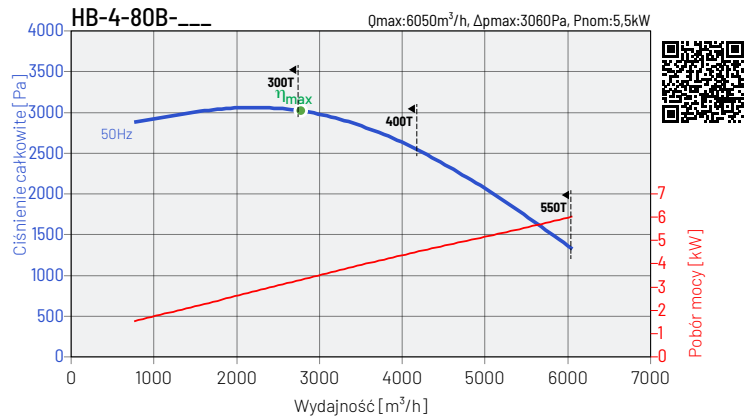

	MC	EC	SR	VSD	η %	N	kW	m ³ /h	Pa	rpm
300T	C	statyczna	1	nie	68,8	73,8	3,39	2 779	3 024	1460
400T	C	statyczna	1	nie	69,5	74,5	3,36	2 779	3 024	1460
550T	C	statyczna	1	nie	70,3	75,4	3,32	2 779	3 024	1460

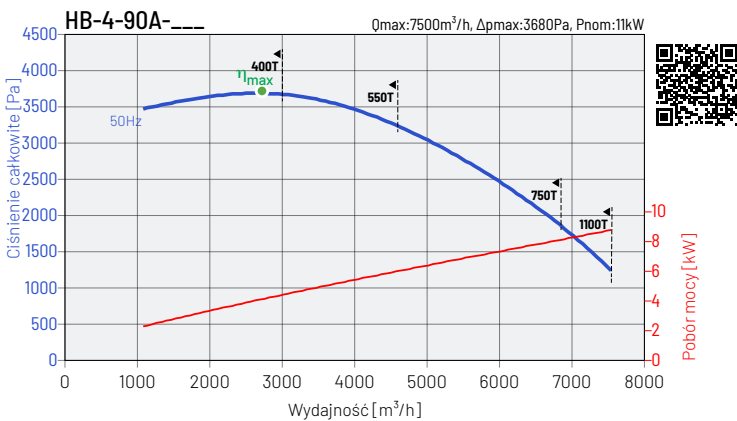

	MC	EC	SR	VSD	η %	N	kW	m ³ /h	Pa	rpm
400T	C	statyczna	1	nie	62,2	66,1	4,30	2 733	3 522	1460
550T	C	statyczna	1	nie	62,9	66,8	4,25	2 733	3 522	1460
750T	C	statyczna	1	nie	63,5	67,4	4,21	2 733	3 522	1465
1100T	C	statyczna	1	nie	64,2	68,2	4,17	2 733	3 522	1475

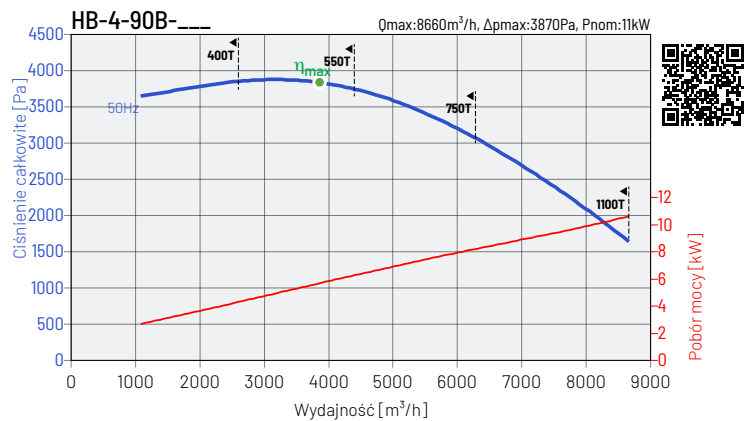

	MC	EC	SR	VSD	η %	N	kW	m ³ /h	Pa	rpm
400T	C	statyczna	1	nie	60,9	64,6	4,52	2 591	3 823	1460
550T	C	statyczna	1	nie	68,1	70,5	5,98	3 956	3 707	1460
750T	C	statyczna	1	nie	68,7	71,1	5,93	3 956	3 707	1465
1100T	C	statyczna	1	nie	70,3	72,8	5,79	3 956	3 707	1475

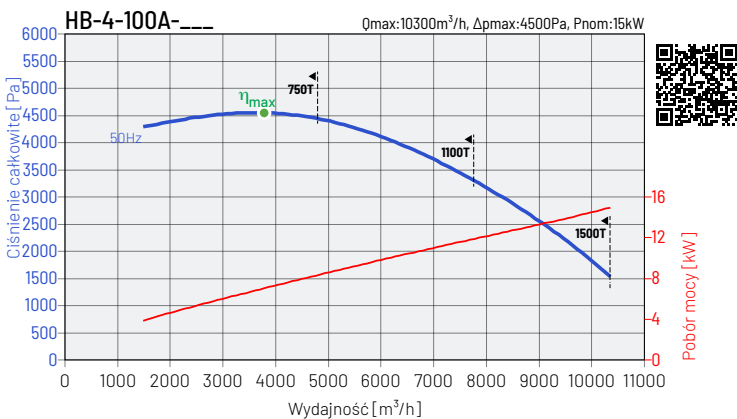

	MC	EC	SR	VSD	η %	N	kW	m ³ /h	Pa	rpm
750T	C	statyczna	1	nie	63,5	65,0	7,13	3 749	4 347	1465
1100T	C	statyczna	1	nie	64,2	65,8	7,06	3 749	4 347	1475
1500T	C	statyczna	1	nie	64,7	66,3	7,00	3 749	4 347	1475

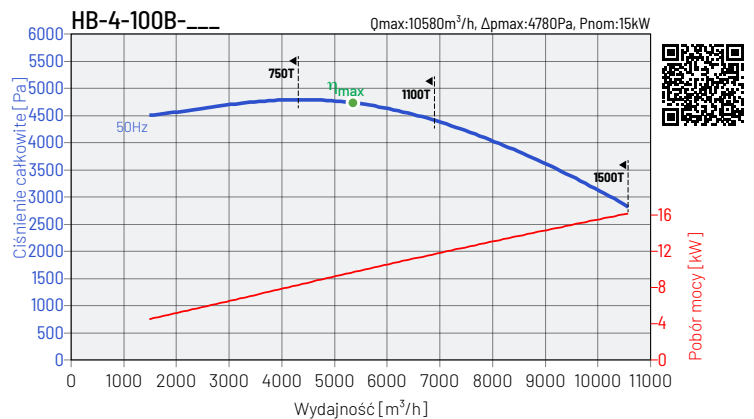

	MC	EC	SR	VSD	η %	N	kW	m ³ /h	Pa	rpm
750T	C	statyczna	1	nie	68,7	69,6	8,21	4 496	4 517	1465
1100T	C	statyczna	1	nie	69,6	69,6	9,93	5 427	4 585	1475
1500T	C	statyczna	1	nie	70,7	70,8	9,78	5 427	4 585	1475

Charakterystyki pracy wentylatorów wyznaczone dla medium o temperaturze 20°C. Poziom ciśnienia akustycznego dB(A), wyznaczany w odległości 1,5m.



WYMIARY

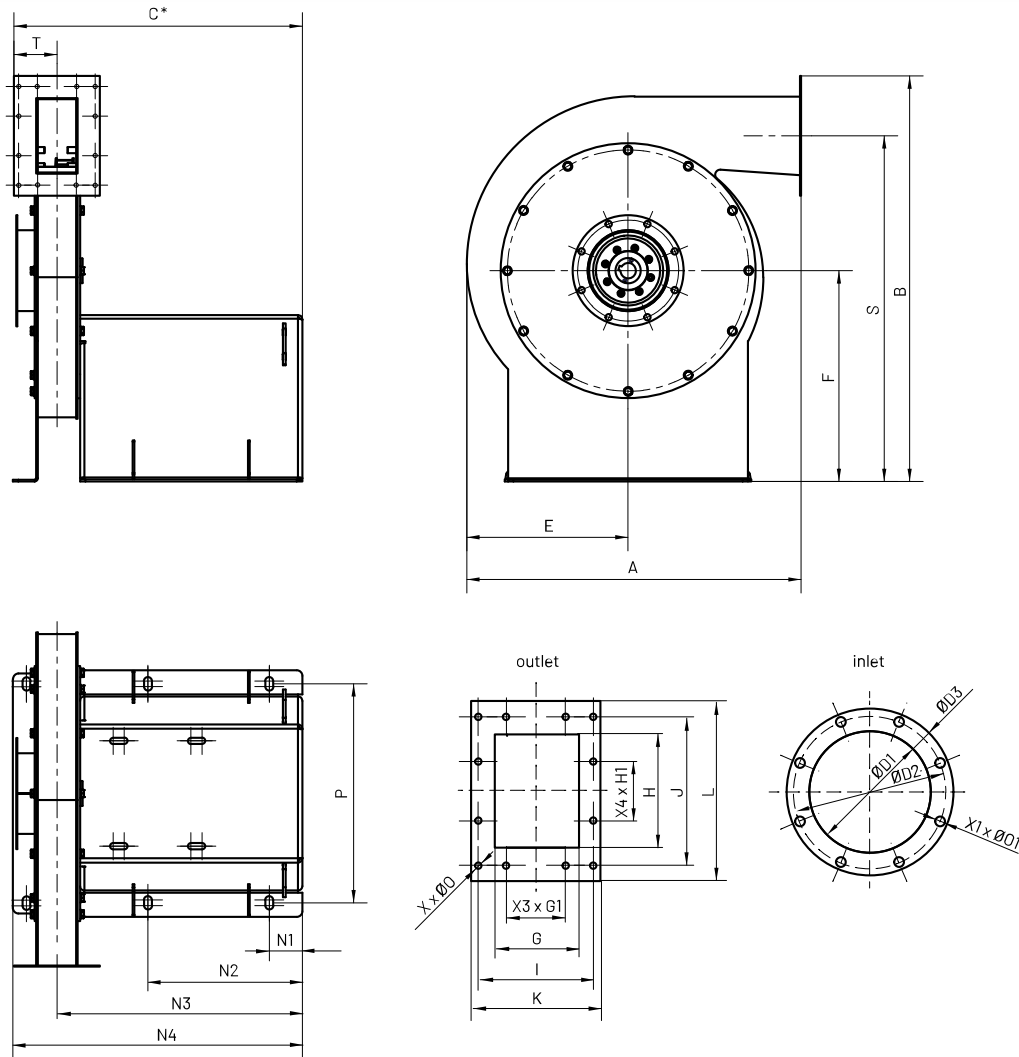

model wentylatora	A	B	C*	ØD1	ØD2	ØD3	E	F	G	H	I	J
	mm	mm	mm	mm	mm	mm	mm	mm	mm	mm	mm	mm
HB-x-40x	603	731	520	140	182	200	291	380	69	132	138	178
HB-x-45x	678	770	528	160	200	220	326	380	77	148	138	178
HB-x-50x	754	814	532	180	219	240	362	390	85	165	138	198
HB-x-56x	837	840	544	200	241	260	405	380	108	185	138	218
HB-x-63x	937	964	544	225	265	290	455	450	108	208	138	238
HB-x-71x	1114	1076	551	250	292	310	512	500	118	235	138	262
HB-x-80x	1209	1261	700	280	332	360	577	600	137	264	178	318
HB-x-90x	1340	1478	838	315	366	390	648	750	155	297	198	318
HB-x-100x	1483	1518	867	355	405	430	720	750	172	330	218	393

* wymiar dla wersji z najdłuższym silnikiem (uzależnione od producenta silnika)

model wentylatora	K	L	N1	N2	N3	N4	P	S	T	X1 x Ø01	X3 x G1	X4 x H1	X x Ø0
	mm	mm	mm	mm	mm	mm	mm	mm	mm	mm	mm	mm	mm
HB-x-40x	155	216	61	280	443	522	395	623	77,5	8x11,5	1x71	1x71	12x7
HB-x-45x	163	232	61	341	447	530	395	654	81,5	8x11,5	1x71	1x71	12x7
HB-x-50x	164	239	61	341	451	539	395	694	82	8x11,5	1x71	1x100	12x7
HB-x-56x	164	239	60	340	462	561	395	720	82	8x11,5	1x71	1x100	12x7
HB-x-63x	164	262	60	340	462	561	395	833	82	8x11,5	1x71	1x100	12x7
HB-x-71x	164	289	59	339	469	575	420	932	82	8x11,5	1x71	1x100	12x7
HB-x-80x	223	348	79	399	589	702	600	1087	111,5	8x11,5	1x71	1x125	12x10
HB-x-90x	221	361	106	526	681	834	740	1297	110,5	8x11,5	1x100	1x125	12x10
HB-x-100x	258	414	86	506	689	864	740	1309	129	8x11,5	1x100	2x125	14x10



FIGURY

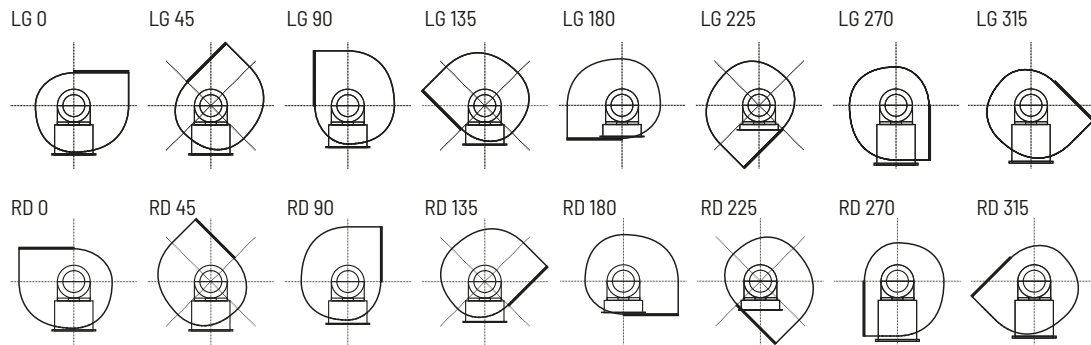



AKCESORIA ELEKTRYCZNE

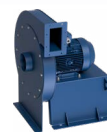

wentylator	falownik L	wyłącznik serwisowy
HB-2-40A-055T	L 0,75 kW	R-S 3-F + SP, 10A
HB-2-40A-075T	L 0,75 kW	R-S 3-F + SP, 10A
HB-2-40A-110T	L 1,5 kW	R-S 3-F + SP, 10A
HB-2-40A-150T	L 1,5 kW	R-S 3-F + SP, 10A
HB-2-40B-075T	L 0,75 kW	R-S 3-F + SP, 10A
HB-2-40B-110T	L 1,5 kW	R-S 3-F + SP, 10A
HB-2-40B-150T	L 1,5 kW	R-S 3-F + SP, 10A
HB-2-45A-110T	L 1,5 kW	R-S 3-F + SP, 10A
HB-2-45A-150T	L 1,5 kW	R-S 3-F + SP, 10A
HB-2-45A-220T	L 2,2 kW	R-S 3-F + SP, 10A
HB-2-45B-110T	L 1,5 kW	R-S 3-F + SP, 10A
HB-2-45B-150T	L 1,5 kW	R-S 3-F + SP, 10A
HB-2-45B-220T	L 2,2 kW	R-S 3-F + SP, 10A
HB-2-45B-300T	L 4,0 kW	R-S 3-F + SP, 10A
HB-2-50A-150T	L 1,5 kW	R-S 3-F + SP, 10A
HB-2-50A-220T	L 2,2 kW	R-S 3-F + SP, 10A
HB-2-50A-300T	L 4,0 kW	R-S 3-F + SP, 10A
HB-2-50A-400T	L 4,0 kW	R-S 3-F + SP, 10A
HB-2-50B-220T	L 2,2 kW	R-S 3-F + SP, 10A
HB-2-50B-300T	L 4,0 kW	R-S 3-F + SP, 10A
HB-2-50B-400T	L 4,0 kW	R-S 3-F + SP, 10A
HB-2-56A-300T	L 4,0 kW	R-S 3-F + SP, 10A
HB-2-56A-400T	L 4,0 kW	R-S 3-F + SP, 10A
HB-2-56A-550T	L 5,5 kW	R-S 3-F + SP, 16A
HB-2-56A-750T	L 7,5 kW	R-S 3-F + SP, 16A
HB-2-56B-300T	L 4,0 kW	R-S 3-F + SP, 10A
HB-2-56B-400T	L 4,0 kW	R-S 3-F + SP, 10A
HB-2-56B-550T	L 5,5 kW	R-S 3-F + SP, 16A
HB-2-56B-750T	L 7,5 kW	R-S 3-F + SP, 16A
HB-2-63A-550T	L 5,5 kW	R-S 3-F + SP, 16A
HB-2-63A-750T	L 7,5 kW	R-S 3-F + SP, 16A
HB-2-63A-1100T	L 11,0 kW	R-S 3-F + SP, 25A
HB-2-63B-550T	L 5,5 kW	R-S 3-F + SP, 16A
HB-2-63B-750T	L 7,5 kW	R-S 3-F + SP, 16A
HB-2-63B-1100T	L 11,0 kW	R-S 3-F + SP, 25A
HB-2-63B-1500T	L 15,0 kW	R-S 3-F + SP, 40A
HB-2-71A-1100T	L 11,0 kW	R-S 3-F + SP, 25A
HB-2-71A-1500T	L 15,0 kW	R-S 3-F + SP, 40A
HB-2-71A-1850T	L 18,5 kW	R-S 3-F + SP, 40A
HB-2-71A-2200T	L 22,0 kW	R-S 3-F + SP, 40A
HB-2-71B-1100T	L 11,0 kW	R-S 3-F + SP, 25A
HB-2-71B-1500T	L 15,0 kW	R-S 3-F + SP, 40A
HB-2-71B-1850T	L 18,5 kW	R-S 3-F + SP, 40A
HB-2-71B-2200T	L 22,0 kW	R-S 3-F + SP, 40A

wentylator	falownik L	wyłącznik serwisowy
HB-2-80A-1850T	L 18,5 kW	R-S 3-F + SP, 40A
HB-2-80A-2200T	L 22,0 kW	R-S 3-F + SP, 40A
HB-2-80A-3000T	L 30,0 kW	R-S 3-F + SP, 63A
HB-2-80A-3700T	na zapytanie	na zapytanie
HB-2-80B-1850T	L 18,5 kW	R-S 3-F + SP, 40A
HB-2-80B-2200T	L 22,0 kW	R-S 3-F + SP, 40A
HB-2-80B-3000T	L 30,0 kW	R-S 3-F + SP, 63A
HB-2-80B-3700T	na zapytanie	na zapytanie
HB-2-80B-4500T	na zapytanie	na zapytanie
HB-2-90A-3000T	L 30,0 kW	R-S 3-F + SP, 63A
HB-2-90A-3700T	na zapytanie	na zapytanie
HB-2-90A-4500T	na zapytanie	na zapytanie
HB-2-90A-5500T	na zapytanie	na zapytanie
HB-2-90A-7500T	na zapytanie	na zapytanie
HB-2-90B-3000T	L 30,0 kW	R-S 3-F + SP, 63A
HB-2-90B-3700T	na zapytanie	na zapytanie
HB-2-90B-4500T	na zapytanie	na zapytanie
HB-2-90B-5500T	na zapytanie	na zapytanie
HB-2-90B-7500T	na zapytanie	na zapytanie
HB-2-100A-5500T	na zapytanie	na zapytanie
HB-2-100A-7500T	na zapytanie	na zapytanie
HB-2-100A-9000T	na zapytanie	na zapytanie
HB-2-100A-11000T	na zapytanie	na zapytanie
HB-2-100B-5500T	na zapytanie	na zapytanie
HB-2-100B-7500T	na zapytanie	na zapytanie
HB-2-100B-9000T	na zapytanie	na zapytanie
HB-2-100B-11000T	na zapytanie	na zapytanie
HB-2-100B-13200T	na zapytanie	na zapytanie
HB-4-40A-009T	L 0,4 kW	R-S 3-F + SP, 10A
HB-4-40A-012T	L 0,4 kW	R-S 3-F + SP, 10A
HB-4-40A-018T	L 0,4 kW	R-S 3-F + SP, 10A
HB-4-40B-009T	L 0,4 kW	R-S 3-F + SP, 10A
HB-4-40B-012T	L 0,4 kW	R-S 3-F + SP, 10A
HB-4-40B-018T	L 0,4 kW	R-S 3-F + SP, 10A
HB-4-45A-012T	L 0,4 kW	R-S 3-F + SP, 10A
HB-4-45A-018T	L 0,4 kW	R-S 3-F + SP, 10A
HB-4-45A-025T	L 0,4 kW	R-S 3-F + SP, 10A
HB-4-45B-018T	L 0,4 kW	R-S 3-F + SP, 10A
HB-4-45B-025T	L 0,4 kW	R-S 3-F + SP, 10A
HB-4-45B-037T	L 0,4 kW	R-S 3-F + SP, 10A
HB-4-50A-018T	L 0,4 kW	R-S 3-F + SP, 10A
HB-4-50A-025T	L 0,4 kW	R-S 3-F + SP, 10A
HB-4-50A-037T	L 0,4 kW	R-S 3-F + SP, 10A
HB-4-50A-055T	L 0,75 kW	R-S 3-F + SP, 10A

wentylator	falownik L	wyłącznik serwisowy
HB-4-50B-025T	L 0,4 kW	R-S 3-F + SP, 10A
HB-4-50B-037T	L 0,4 kW	R-S 3-F + SP, 10A
HB-4-50B-055T	L 0,75 kW	R-S 3-F + SP, 10A
HB-4-56A-037T	L 0,4 kW	R-S 3-F + SP, 10A
HB-4-56A-055T	L 0,75 kW	R-S 3-F + SP, 10A
HB-4-56A-075T	L 0,75 kW	R-S 3-F + SP, 10A
HB-4-56B-037T	L 0,4 kW	R-S 3-F + SP, 10A
HB-4-56B-055T	L 0,75 kW	R-S 3-F + SP, 10A
HB-4-56B-075T	L 0,75 kW	R-S 3-F + SP, 10A
HB-4-56B-110T	L 1,5 kW	R-S 3-F + SP, 10A
HB-4-63A-075T	L 0,75 kW	R-S 3-F + SP, 10A
HB-4-63A-110T	L 1,5 kW	R-S 3-F + SP, 10A
HB-4-63A-150T	L 1,5 kW	R-S 3-F + SP, 10A
HB-4-63B-075T	L 0,75 kW	R-S 3-F + SP, 10A
HB-4-63B-110T	L 1,5 kW	R-S 3-F + SP, 10A
HB-4-63B-150T	L 1,5 kW	R-S 3-F + SP, 10A
HB-4-71A-150T	L 1,5 kW	R-S 3-F + SP, 10A
HB-4-71A-220T	L 2,2 kW	R-S 3-F + SP, 10A
HB-4-71A-300T	L 4,0 kW	R-S 3-F + SP, 10A
HB-4-71B-110T	L 1,5 kW	R-S 3-F + SP, 10A
HB-4-71B-150T	L 1,5 kW	R-S 3-F + SP, 10A
HB-4-71B-220T	L 2,2 kW	R-S 3-F + SP, 10A
HB-4-71B-300T	L 4,0 kW	R-S 3-F + SP, 10A
HB-4-80A-220T	L 2,2 kW	R-S 3-F + SP, 10A
HB-4-80A-300T	L 4,0 kW	R-S 3-F + SP, 10A
HB-4-80A-400T	L 4,0 kW	R-S 3-F + SP, 10A
HB-4-80A-550T	L 5,5 kW	R-S 3-F + SP, 16A
HB-4-80B-300T	L 4,0 kW	R-S 3-F + SP, 10A
HB-4-80B-400T	L 4,0 kW	R-S 3-F + SP, 10A
HB-4-80B-550T	L 5,5 kW	R-S 3-F + SP, 16A
HB-4-90A-400T	L 4,0 kW	R-S 3-F + SP, 10A
HB-4-90A-550T	L 5,5 kW	R-S 3-F + SP, 16A
HB-4-90A-750T	L 7,5 kW	R-S 3-F + SP, 16A
HB-4-90A-1100T	L 11,0 kW	R-S 3-F + SP, 25A
HB-4-90B-400T	L 4,0 kW	R-S 3-F + SP, 10A
HB-4-90B-550T	L 5,5 kW	R-S 3-F + SP, 16A
HB-4-90B-750T	L 7,5 kW	R-S 3-F + SP, 16A
HB-4-90B-1100T	L 11,0 kW	R-S 3-F + SP, 25A
HB-4-100A-750T	L 7,5 kW	R-S 3-F + SP, 16A
HB-4-100A-1100T	L 11,0 kW	R-S 3-F + SP, 25A
HB-4-100A-1500T	L 15,0 kW	R-S 3-F + SP, 40A
HB-4-100B-750T	L 7,5 kW	R-S 3-F + SP, 16A
HB-4-100B-1100T	L 11,0 kW	R-S 3-F + SP, 25A
HB-4-100B-1500T	L 15,0 kW	R-S 3-F + SP, 40A

Numery artykułów

40016450 FALOWNIK 0,4kW	40016456 FALOWNIK 7,5kW	91040908-01 R-S 3-F + SP, 10A
40016451 FALOWNIK 0,75kW	40016457 FALOWNIK 11,0kW	91040908 R-S 3-F + SP, 16A
40016452 FALOWNIK 1,5kW	40016458 FALOWNIK 15,0kW	91040910 R-S 3-F + SP, 25A
40016453 FALOWNIK 2,2kW	40016459 FALOWNIK 18,5kW	91040924 R-S 3-F + SP, 40A
40016454 FALOWNIK 4,0kW	40016460 FALOWNIK 22,0kW	91040911-03 R-S 3-F + SP, 63A
40016455 FALOWNIK 5,5kW	FALOWNIK 30,0kW	