

Pipe- / Roof plastic industrial fan



Agent :

For use in Ex zones





Not for use in Ex zones

Preface

This operating manual is the driver's license for operation of this COLASIT fan. It is the main source of information and also the safety guideline. It deserves your full attention - please read it carefully.

The contents of this operating manual are subject to change without notice in order to take technical progress into account.

The manual contains icons that appear in the margin and indicate special dangers and important instructions.

	Very important note
	Universally applicable warnings which concern your personal safety.
	Indicates electrical dangers.
	Indicates process control dangers.

The entire operating manual consists of 3 parts:

Part 1: General

Part 2: Components

Part 3: Certificates

Table of contents

Part 1: General	4
1 General.....	4
1.1 Definition.....	4
1.2 Production of COLASIT-fans.....	4
1.3 Warranty.....	4
1.4 Safety review.....	5
1.5 Personnel qualifications.....	5
1.6 Possible emergencies.....	5
1.7 Safety officer (SO).....	5
1.8 General risk matrix.....	6
1.9 EU conformity of the COLASIT fan.....	7
1.10 Restrictions when commissioning.....	7
1.11 General operation conditions.....	7
2 Explosion protection.....	7
2.1 Fan Ex marking.....	8
2.2 Correct installation of ATEX fan.....	9
3 Shipping, unpacking, inspection, storage.....	9
4 Installation, configuration.....	9
5 Commissioning, initial startup, test run.....	10
5.1 Inspection of the installation and settings.....	10
5.2 Drive.....	10
5.3 Electrical installations.....	11
6 Operation.....	11
6.1 Safety instructions.....	11
6.2 Putting out of operation.....	11
7 Maintenance, repair, cleaning.....	12
7.1 Preparation.....	12
7.2 Performance.....	12
8 Spare parts.....	13
9 Operating instructions.....	13
10 Logbook.....	13
11 Disposal.....	14
12 Troubleshooting.....	14
13 Retrofittable original accessories.....	15
14 Fan identification.....	15
Part 2: Units.....	15
15 Design and function of the CRDV 200-315.....	15
16 Dimensional drawings.....	16
16.1 Dimensions of the CRDV 200-315.....	16
16.2 Dimensions of the CRDV 200-315.....	17
17 Assembly instructions.....	18
17.1 Assembly instructions CRDV 200-315.....	18
18 Spare parts lists.....	20
18.1 Spare parts list for CRDV 200-315 with direct drive.....	20
Part 3: Certification.....	21
19 Certifications.....	21
19.1 EU declaration of conformity.....	21
19.2 ATEX-Declaration of Conformity.....	22
19.3 Further certificates.....	24
20 Form for the correct assembly ATEX-fans.....	25

Part 1: General

1 General

OBLIGATIONS

Prior to any work done on or with the fan, we place you under an obligation to read this operating manual and any further contractors' operating instructions carefully and through to the end.

Should anything not be clear, please get in touch with us immediately. Do not put the fan into operation as long as uncertainties exist.

As soon as you start up the fan you confirm that you have read and understood the operating manual.



After acquainting yourself with the fan and its operational performance together with your production processes, we recommend that you make a note of the different modes of operation in a "process instruction".

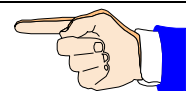

Together with this operating manual, any acceptance documents, works acceptance certificates and the EU Declaration of Conformity, the process instruction forms part of the complete system documentation.

For the fan, a separate risk analysis was conducted as a prerequisite for writing this operating manual. Risks were evaluated and any remaining residual risks are pointed out in this operating manual.

When extracting aggressive gases, it is imperative to review the suitability of the materials:

- Once the principal or the operator has notified us of the gas mix and the maximum operating temperature, the suitability and any applicable restrictions will be confirmed in the data sheet of COLASIT AG.
- **In the absence of a written notification with regard to the extracted medium by the principal, the operator is responsible without limitation for assessing the suitability for the operation of the ventilator.**

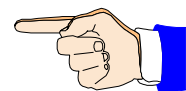

1.1 Definition

The term "COLASIT fan" stands for a Swiss high-quality product and contains all the components and individual parts as specified in the purchase order or in the material parts list, which, when assembled, form a functional unit.

1.2 Production of COLASIT-fans

The fan was manufactured using modern production methods and was extensively tested both during manufacture and as a finished product by the COLASIT quality assurance system. The methods and processes used in production and monitoring correspond to the state of the art. The personnel entrusted with production of the fan have the appropriate skills and possess valid qualifications.

All fans with engine are subjected to a successful test run at the manufacturer's production facilities.

1.3 Warranty

Warranty ends on the date stated in the general terms of sale and delivery. Warranty is limited to the delivery of spare parts or the repair of defective parts at the manufacturer's factory. Any further claims or the replacement of non-repairable or wear parts are excluded.

We guarantee the availability of spare parts identical in construction to the original over a period of 10 years effective from the date of delivery.

COLASIT only guarantees the durability of materials on condition that technological data was available before production.

Any change in the conditions of use is only permissible after approval by COLASIT; otherwise this will entail loss of warranty.

Any changes or repair work during the warranty period may only be made by our fitters or with our written consent.

We refer to the limitation of warranty noted in the “Motor“-section in the case where a frequency converter supplied by a third party is fitted.

The fan must be deployed and used in accordance with the conditions mentioned in this operating manual. Only in this way can its function be guaranteed and dangers to persons and material be excluded during operation. We accept no liability nor guarantee any claims for damages arising from nonobservance of this manual or from inappropriate operation.



1.4 Safety review

After installing the fan, we recommend the operator conducts a review of the entire operational environment. In this way it can be guaranteed that neither the fan will suffer damage nor that the fan will cause any damage.

1.5 Personnel qualifications

The fan may only be put into operation, handled, operated, maintained and cleaned by trained personnel who are authorised (and competent) to carry out such work.

The personnel must possess the appropriate skills needed to operate the fan and be familiar with the effects of the reactions caused by the fan.

The personnel qualified to operate the fan must be able to react adequately and correctly in case of a fault or an emergency.

1.6 Possible emergencies

An emergency may result from the bursting or melting of plastic components as a result of mechanical damage or chemical and thermal influences. In this case, parts may fly off or vapour may be produced that may be hot, corrosive, poisonous, irritating or inflammable (e.g. hydrochloric acid vapour occurring from burning PVC).

There may be a danger of fire under certain circumstances.

For the choice of the correct fire-extinguishing devices and the positioning of the firefighting equipment, please follow the recommendations of your local fire station.

1.7 Safety officer (SO)

The function of the safety officer or his representative is defined in the operating company's organisational chart. The name of the person must be known to all personnel who are responsible for the fan.

The operating company defines his competencies and his area of responsibility.

The safety officer approves the fan for operation.

1.8 General risk matrix

Operation

The safety regulations prevailing at the operator's location are mandatory and must be observed at all times. Before making an intervention, the process must be stopped, i.e. all mechanical movement must be stopped and it must be ensured that no automatic motion can occur.



Missing safety devices

If the fan is equipped with safety devices, they may neither be modified nor removed. Further safety devices of suitable design must be fitted by the operator and are subject to his control.



Disregard of safety precautions

Please implement all safety measures so that the fan, together with its associated equipment, can operate properly and any danger to persons, materials and products can be excluded.



Putting the fan out of operation

In the case of damage to or failure of safety devices, the fan must be stopped and put out of operation. It may only be put into operation again when the safety devices are fully functional again.



Electricity

When any work is carried out on the fan, the electric motor must be deenergised and secured to prevent it from switching on. The main power switch must be secured against operation by third parties using a lockable device (e.g. padlock) by the persons working on the fan. **Full disconnection of the motor is only permissible in case of complete removal!**

The safety regulations for work on electrical equipment prevailing at the place of operation must be observed at all times and be available for reference at the place of operation.



Electrostatic charge

Media flowing through the plastic components may cause the buildup of electrostatic charge. These are harmless to persons who do not react to electrical impulses in the body

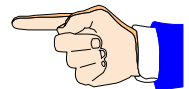

Unsuitable materials

Through the use of inappropriate materials, the fan and/or parts may be damaged or become non-functional. Please always use original spare parts and contact the manufacturer in any case of doubt.



Dangerous media

Depending on the mode of operation, fan parts may come in contact with dangerous media.

Work on the fan or carrying out maintenance work is not allowed during operation. Before carrying out any work, any dangerous media must be removed from the system and, when required, must be neutralized and secured in such a way that an inflow of dangerous media is prevented.



1.9 EU conformity of the COLASIT fan

The fan was designed, built and tested to Directive 2006/42/EC.

In addition to this EU Directive and EN standards which have the equivalent status of a Swiss standard, Swiss safety and accident-prevention regulations have also been taken into account.

An EU Declaration of Conformity in terms of the guidelines 2006/42/EC on machines will be issued along with the fan.

1.10 Restrictions when commissioning

We stipulate that putting into operation is prohibited as long as the fan, including all parts belonging to it or equipment connected to it, has not been installed and checked out and until the operating manual has been read completely before commissioning.

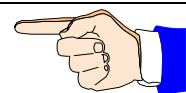

We stipulate that the fan may only be put into operation when the safety inspector has given his approval. He is obliged to record this approval in a protocol.

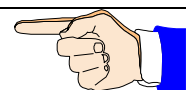

The disregard of these stipulations constitutes negligence.

1.11 General operation conditions

The permissible operating conditions are indicated on the manufacturer's plate.

The fan is not suitable for the transport of solids in the air flow. This operating mode will lead to the destruction of the fan.

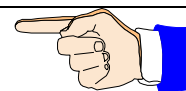

The ducts on the intake and delivery sides must always be open. A closed duct will lead to a rise in temperature which could cause the destruction of the fan.

The minimum air speed through the fan is 3 meters per second.

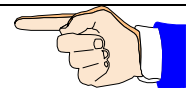

If exhaust air with a temperature $> 5^{\circ}\text{C}$ flows through the fan, it can be used up to an ambient temperature of -20°C .

The standard motors are designed for normal operating conditions (ambient temperature -20 to $+40^{\circ}\text{C}$, altitude below 1000 m above sea level, air pressure up to 1050 hPa). In case of any divergence from these conditions, please contact COLASIT.

Compliance with these operating conditions is the responsibility of the operator.

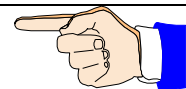

2 Explosion protection

COLASIT plastic fans are suitable for the conveyance of gases in Zone 1 or 2 (Equipment Category 2 or 3) depending on the model. COLASIT plastic fans are not suitable for the conveyance of gases in Zone 0 (Equipment Category 1).

The zone classification of the conveyed medium and the site of installation must be made known by the fan operator so that COLASIT can take the necessary measures to prevent the risk of ignition.

The explosion-proof COLASIT fans are not suitable for the conveyance of explosive dusts.

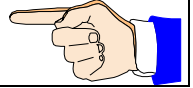

No modifications may be made to ATEX-certified fans. All work on the fan may only be carried out by ATEX-trained skilled personnel. Otherwise the ATEX Certificate will lose its validity.

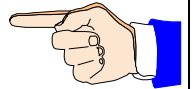

On ATEX certified fans, the external grounding terminal of the motor and fan must be connected to a potential equalization system.

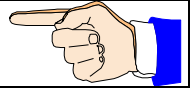

Motors with protection type "eb" are standard for using in the explosion-proof design of our fans. The standard version of the motors used complies with temperature class T3 (maximum surface temperature 200°C).

As special-purpose design, motors with protection type "db (or db eb)" or motors with temperature class T4 (maximum surface temperature 135°C) are also available.

The user must define a suitable temperature class for his application that does not reach the ignition temperature of his conveyed medium.

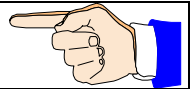

Please also observe the specifications in the operating instructions of the motor manufacturer. The thermal motor protection must be connected in compliance with the manufacturer's specifications (operating instructions).

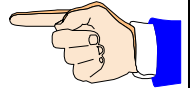

If a frequency converter is fitted, you have to use pressure-proof enclosed motors. In addition, a certified PTC resistor releasing device must be fitted. The following specifications must be included on the motor rating plate: min and max frequencies, min and max speeds, min and max torque or output, limit temperature PTC and PTC release time.



2.1 Fan Ex marking

The Ex marking is located on the rating plate of each ATEX fan. On a fan of Equipment Category 2 (Zone 1), it looks like this

CE  **II 2/3G Ex h IIB+H₂ T3 Gb/Gc**



CE-marking



Marking denoting prevention of explosions

II

Equipment Category II, for all Ex applications which do not fall in Class I (mines and surface workings).

2/3G

Equipment Category inside/outside the fan
Equipment Category 2 is the equivalent of Zone 1 and
Equipment Category 3 is the equivalent of Zone 2
"G" fan for the conveyance of explosive gases

Ex h

Protection type „design safety“

IIB+H₂

Equipment Category (gases)

T3

Temperature class T3: Max. surface temp. 200 °C
T4: Max. surface temp. 135 °C

Gb/Gc

Equipment Protection Level (EPL)

2.2 Correct installation of ATEX fan

The fan must be installed properly to guarantee trouble-free operation. To document proper installation, you will find a form on the last pages of this operating manual. The fitter must confirm the proper installation item for item on this form.

The signed form must be kept by the safety officer or operating company.

COLASIT also offers a comprehensive installation service for fans.

3 Shipping, unpacking, inspection, storage

The fan is completely assembled and can be delivered in a closed film wrapping. Please make sure the delivery corresponds to the shipping documents.

Please examine the packaging for external damage and report any damage immediately to the transport company, the supervisor and the manufacturer.

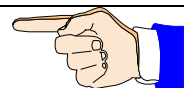

Please handle the fan with care. During transportation, only apply strain on the steel parts. Plastic is sensitive to impact and knocks, especially in the temperature range under +5°C.

When the film is removed, the intake and pressure nozzles are open and unprotected against the intrusion of foreign objects. Therefore, please do not remove the protective film until shortly before final installation.

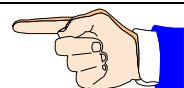

Storage

If the fans are not put into operation immediately, store them in a clean dry place where they are protected from impacts, vibrations, and temperature fluctuations and where the air humidity is under 90%.

If these storage conditions are not available, switch the fans on at regular intervals to exclude the risk of condensate forming. Before switching on, unscrew the condensate drain plugs each time and replace them afterwards.



Store the fan in a dry, weather-protected place and cover with a tarpaulin to protect it from dust and soiling. If stored for over one year, test whether the fan bearings rotate freely before putting into operation.

4 Installation, configuration

Before installation, check whether all the locking screws (including the motor screws) are tightened properly. Check the electrical connections if wired at the factory.

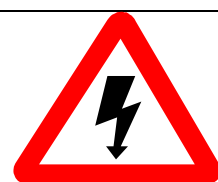

Before installation, check that there are no foreign bodies in the coil or in the intake and pressure connections.

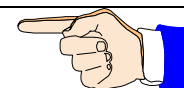

The fan must be installed at a location provided and prepared by the customer and must be secured and connected in such a way that any possible vibration occurring can be absorbed by the vibration dampers supplied by COLASIT.

If no ducting is foreseen on the intake side, the intake connection should be protected by a sturdy protective grating (10mm mesh) to be provided by the customer. If small particles can be sucked in which could cause damage to the fan, a protective grating with a correspondingly small mesh must be fitted.

Connection ducting on the pressure side must be routed to prevent the backflow of foreign bodies, rainwater or condensate into the fan. To ensure this, please use the COLASIT condensate drain nozzles.

Due to the possibility of noise nuisance, we recommend that the fan should not be installed in the immediate vicinity of workplaces.

5 Commissioning, initial startup, test run

The fan should only be put into operation after inspection and approval by the safety officer.

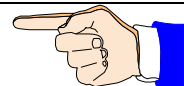

5.1 Inspection of the installation and settings

Check list:

Prior to commissioning and initial start-up, it must be guaranteed that

- the fan is installed vibration-free and mechanically secured,
- all components are cleaned both on the inside and the outside and are free from foreign bodies,
- all intake and pressure ducts connections are leak-proofed
- all rotating parts are protected against unintentional contact,
- the electrical connections are installed and their function tested,
- a lockable revision switch is available to which the fan is connected
- the equipment is functionally tested,
- the safety inspector has made sure that safety equipment exists,
- the operating personnel is familiar with the operating manual,
- the safety inspector has given his approval for the operation of the installation and that no external persons are present in the plant area

If envisaged by procedural regulations provided by the operator, minutes have to be taken on the commissioning work, including the observance of the check list.

5.2 Drive

The fan is driven by an electric motor which is connected to the impeller shaft either directly or via a V-belt.

The motor electrical specifications are indicated on the motor's rating plate or in the motor manufacturer's data sheet.

When speed is controlled by means of a frequency converter, the maximum speed is limited by COLASIT to the value indicated on the manufacturer's rating plate.

If the frequency converter is not supplied by COLASIT, the operator is responsible for compliance with the maximum speed limitation. In this case, COLASIT will not assume any liability for damage that may be attributed to exceeding the maximum speed.



In order not to overload the fan mechanically, acceleration and braking times of at least 15sec. must be observed for < 1.5kW rated motor power and 30sec. for > 1.5kW rated motor power.

Depending on the maximum available starting current of the frequency inverter, a longer acceleration time may be necessary to avoid an error message.

5.3 Electrical installations

The electrical installations may only be carried out by an authorised electrician in accordance with the regulations prevailing at the site at which the fan is installed.

To interrupt the power supply, a revision switch must be provided. It is advisable to mount this switch in the vicinity of the emergency exit.

Please request confirmation from an in-house electrician that the electrical installations were carried out and tested in accordance with regulations, that all functions were tested (or simulated) and that the rotational direction is correct.

Warning

Do not turn power on or off without prior warning to persons in the area where the fan is operating. Switching operations must be co-ordinated with other functions in the working area of the fan.

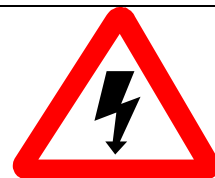

6 Operation

6.1 Safety instructions

The fan must be operated according to this manual. This will avoid the occurrence of any damage.

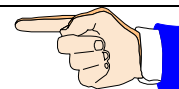

Supervision

The fan must not be operated unattended as long as it conveys substances whose reactions are unknown or if unexpected reactions are anticipated. If supervision must be withdrawn for operational reasons, this must be reported to the safety officer and the system must be secured in such a way that no unauthorized intervention can be carried out. The safety officer must decide on issues regarding supervision.



6.2 Putting out of operation

An internal process instruction must regulate the work to be carried out as well as the preparatory work for putting back into operation (e.g. cleaning).

7 Maintenance, repair, cleaning

7.1 Preparation

Before any work is carried out on the fan, the fan must be set to its "safety position".

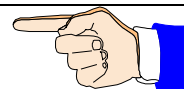

The „safety position“ is defined as follows:

- The drive must be currentless and the revision switch secured against switching on,
- The fan impeller can be manually rotated,
- Fan must be flushed with fresh air and be condensate-free,
- Fan must be at room temperature,
- Personal protective equipment must be available and it must be worn. (Use of protective gloves because of sharp edges, ear protectors if necessary).
- A sign, e.g. „Under-repair“, must be attached to the system,
- The safety devices may be removed,
- The work to be carried out must not be done under time pressure,
- The general and specific regulations on accident prevention as well as the EKAS guidelines (Switzerland) must be observed,
- The safety officer must be informed about the nature and course of the work,

If the intake and delivery ducts of the fan are dismantled for a longer period of time, the openings must be closed off.

7.2 Performance

The fan must be maintained in accordance with the Maintenance Plan below. The maintenance work carried out must be noted down in the logbook (see the section on Logbook).

Every week	Every month	Every year
<ul style="list-style-type: none"> • Make a visual inspection of fan for damage, leaks, corrosion and attachment. • Check the smooth running of the fan and electric motor. 	<ul style="list-style-type: none"> • Check the impeller and casing for deposits and clean if necessary. • Remove any dust deposits on the fan and motor. • Check the flexible transitions from fan to duct system for leaks and state. • Check the function of the condensate nozzle. • Check the state of the vibration dampers. • Check the state of the hub gasket (if fitted). 	<ul style="list-style-type: none"> • Carry out a thorough cleaning of the entire fan (including impeller). • Check the parts in contact with the conveyed medium for corrosion. • Check the minimum clearance between the impeller and casing (minimum 1% of intake diameter, maximum 20mm). • Measure the vibrations at bearings (KA) or motor (DA). Alarm according to ISO 14694: ≤ 3.7 kW, categorie BV-2: 14.0 mm/s (r.m.s.) or ≤ 300 kW, categorie BV-3: 11.8 mm/s (r.m.s.). • Check the stands for damage and stability. • Check all screw unions for firm seating.

Components which are not intended for repair by the operator must be sent to the manufacturer or agent for repair or replacement (e.g. damaged impeller).

Your agent or COLASIT
also offers customer services

Manufacturer	COLASIT AG
	Faulenbachweg 63 CH 3700 Spiez / Switzerland
	Tel.: 0041 (0)33 655 61 61
	Fax.: 0041 (0)33 654 81 61
Agent	e-mail info@colasit.ch
	see front page

8 Spare parts

Please identify components by means of the position and drawing numbers as well as the order number and type designation.

Use only original spare parts. Our warranty becomes null and void if other or unapproved components are used.

Please address your spare parts order to our customer service department.

9 Operating instructions

To operate the fan, we recommend the production of process instructions. These documents are intended to simplify repetitive workflows, reduce the risk of incorrect operation and are a valuable aid for training and when personnel changes occur.

If the fan must be qualified, process instructions are an absolute prerequisite.

You will find important instructions on how to produce process instructions in various chapters of this operating manual.

To help ensure the safe operation of the fan, COLASIT offers the service of reviewing process instructions prepared by the operator.

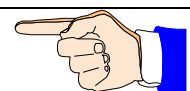

10 Logbook

For your own safety and as an aid to personal responsibility, we recommend the keeping of a logbook for the entire period during which the fan is in service.

All events should be recorded in the logbook.

In case of damage and also in case of an accident, this document is the first source of information.

For example, enter the date and your signature:

- Start and end of a work cycle
- Special events, even if they do not concern the fan itself (e.g. power failure, alarm)
- Change of supervision staff (e.g. in case of shift operation),
- Repairs carried out and spare parts installed,
- Putting out of operation,
- Special instructions,
- etc.

11 Disposal

Before disposing of plastics and other components (complete or as broken parts), please clean them as necessary to avoid any danger to the environment.

Dispose of the components properly. Instruct a waste disposal company to do this or return them to us for disposal.

12 Troubleshooting

If faults occur, we recommend you identify and clear them using the following table.

If the fault cannot be cleared, please contact our customer service department.

Fault	Possible causes	Remedy
Fan not running smoothly	Impeller imbalance	Rebalance by specialist company
	Impeller caked up	Clean carefully rebalance if necessary
	Material corrosion on impeller due to aggressive conveyed medium.	Consult the manufacturer
	Impeller deformed due to high temperature.	Consult the manufacturer. Install new impeller. Check bearings
Leak at shaft bushing	Seal not suitable for application	Consult the manufacturer
Leak on sleeves	Sleeves defective	Replace sleeves
	Tensioning straps not tight enough	Retighten tensioning straps
Fan output too low	Incorrect rotation direction of impeller	Change rotation direction
	Pressure losses in ducts too high	Change duct arrangement
	Restrictors not or only partly open	Check opening on site
	Intake or pressure duct blocked	Remove blockage
Fan fails to reach its rated speed	Electrical switching mechanisms incorrectly adjusted	Check motor protection setting and reset if necessary
	Motor winding defective	Please consult the manufacturer
	Drive motor drive not correctly designed	Please consult manufacturer to verify starting torque
Grinding noises when fan is running or starting	Intake duct fitted under tension	Remove intake duct and realign

13 Retrofittable original accessories

If not already a part of our scope of supply, these original parts are available ex stock when ordered.

- Frequency converters
- Roof-mounting plinth
- Insulated roof-mounting plinth
- Roof-mounting flange
- Fixing for wall-mounting
- Fixing for ceiling / floor-mounting
- Self-acting flap in intake
- Elastic sleeves
- Condensate drains
- Protective grating for intake-and outtake flap

14 Fan identification

The following rating plate is affixed to each COLASIT fan:

- 1 Manufacturer
- 2 Field for CE marking and applicable standards
- 3 ATEX-identification, for details see the section on Explosion Protection
- 4 Fan specifications: fan type, casing design, material of casing and impeller, order number and date of manufacture.
- 5 Technical specifications

Part 2: Units

15 Design and function of the CRDV 200-315

All impellers in this series are balanced to better than G 6.3 according to ISO 21940.

The casing with its thermoplastic rear panel is screwed onto the support base and can be easily dismantled for inspection or cleaning purposes.

The fans are available in 2 standard designs

- As a roof ventilator mounted on a roof-mounting plinth or on a chimney-pipe supplied by the customer
- As an in-line fan mounted directly in ducting

As a basic principle, plastic fans are to be installed on the intake side in order to avoid leaks.

16 Dimensional drawings

16.1 Dimensions of the CRDV 200-315

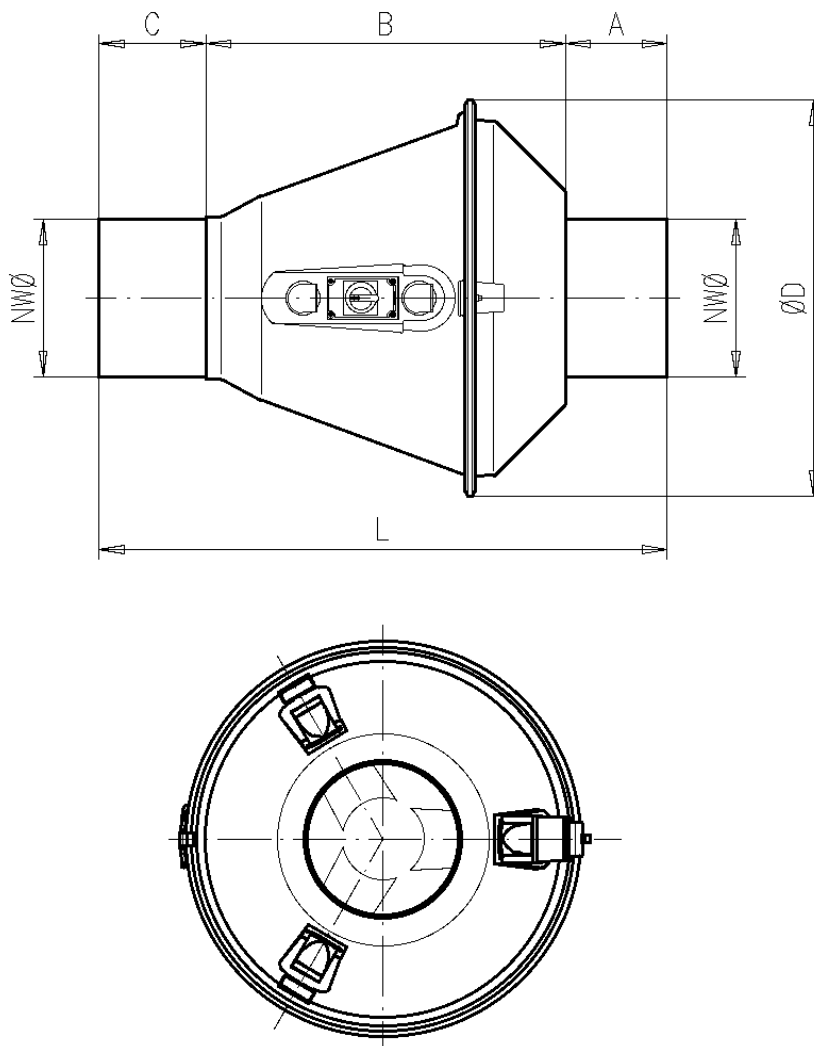

Ventilator Typ CRDV	Measurements					
	NWØ	A	B	C	ØD	L
200R	200	117	558	125	575	800
250R	250	162	572	170	635	904
315R	315	212	598	220	705	1030

16.2 Dimensions of the CRDV 200-315

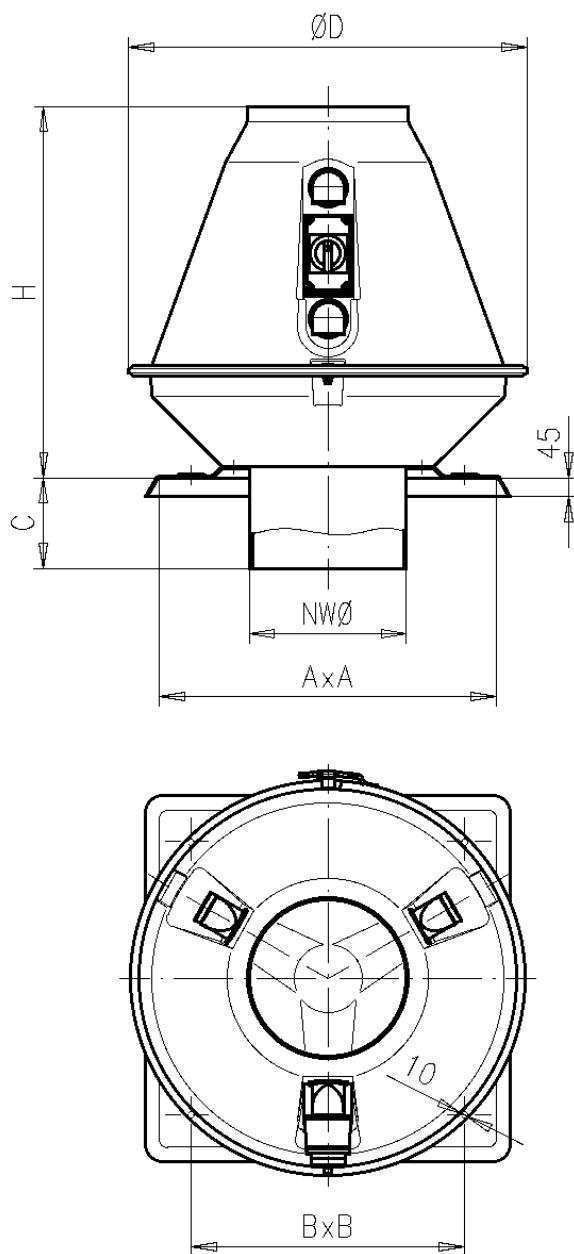

Ventilator Typ CRDV	Measurements					
	NW \varnothing	A	B	C	$\varnothing D$	H
200D	200	495	400	100	575	575
250D	250	535	435	144	635	590
315D	315	625	520	194	705	615

17 Assembly instructions

17.1 Assembly instructions CRDV 200-315

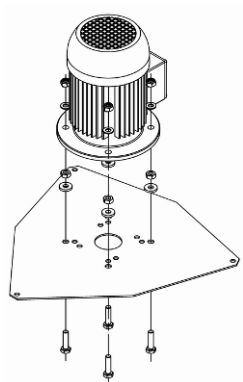

1. Attach motor to the motor plate

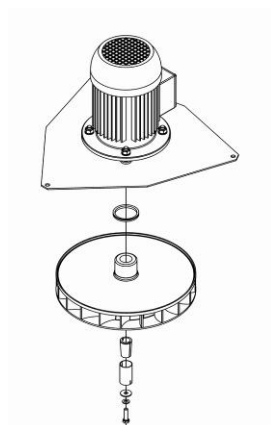

2. Mount impeller and V-ring seal

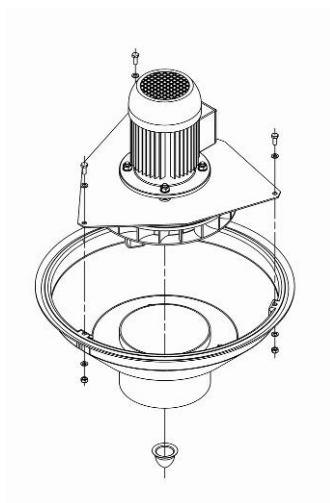

3. Screw motor-plate, lower part of housing and intake together, adjust impeller (5mm minimum clearance to casing), tighten impeller and put on hub cap

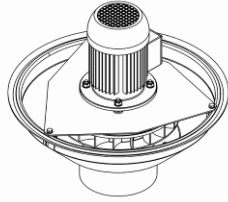
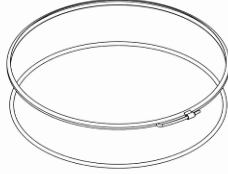
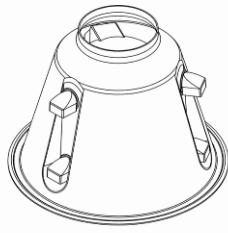

4. Mount round seal on upper part of housing on the lower part, fasten both housing halves together using the retaining ring

Dismantle in the same way but in reverse order

18 Spare parts lists

18.1 Spare parts list for CRDV 200-315 with direct drive

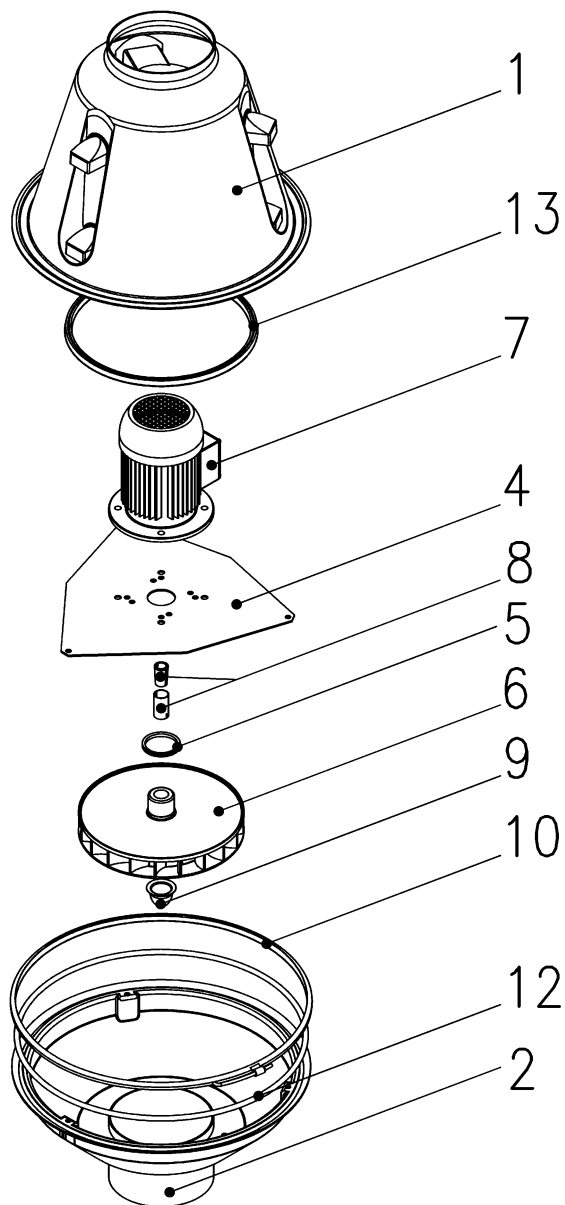

- 1 Hood complete
- 2 Bottom part
- 4 Motor plate
- 5 V-seal
- 6 Impeller
- 7 Motor

- 8 Clamp adapter set
- 9 Hub cap
- 10 Clamp ring
- 11 Round gasket
- 12 Profiled seal

Part 3: Certification

19 Certifications

19.1 EU declaration of conformity

EU-Konformitätserklärung

Déclaration UE de conformité

EU declaration of conformity

Wir

Nous

We

COLASIT AG

Faulenbachweg 63

CH-3700 Spiez

erklären in alleiniger Verantwortung, dass das Produkt
déclarons de notre seule responsabilité que le produit
bearing sole responsibility, hereby declare that the product

Kunststoff-Industrieventilator
Ventilateur industriel en plastique
Plastic industrial fan
CRDV 200-315

auf das sich diese Erklärung bezieht, mit der/den folgenden Norm(en) oder normativen Dokumenten
übereinstimmt:

auquel se rapporte la présente déclaration est conforme aux normes ou aux documents normatifs suivants:
referred to by this declaration is in conformity with the following standards or normative documents:

Bestimmungen der Richtlinie Désignation de la directive Provisions of the directive	Titel und/oder Nummer sowie Ausgabedatum der Norm(en): Titre et/ou numéro ainsi que date d'émission de la/des norme(s): Title and/or number and date of issue of the standard(s):
2006/42/EG: Maschinensicherheit 2006/42/CE: Sécurité des machines 2006/42/EC: Machinery safety	EN ISO 12100: 2010 EN ISO 13857: 2019 EN 60204-1: 2018
2014/30/EU: Elektromagnetische Verträglichkeit 2014/30/UE: Compatibilité électromagnétique 2014/30/EU: Electromagnetic compatibility	EN IEC 61000-6-2: 2016
Name und Adresse des Dokumentationsverantwortlichen: Nom et adresse de la personne responsable de la documentation: Name and address of the person authorised to compile the relevant technical documentation:	Andreas Roth COLASIT AG Faulenbachweg 63 CH-3700 Spiez
Bei Verwendung im Ex-Bereich Pour utilisation dans zone Ex For use in Ex zones	
2014/34/EU: Geräte und Schutzsysteme zur bestimmungsgemässen Verwendung in explosionsgefährdeten Bereichen 2014/34/UE: Appareils et système de protection destinés à une utilisation correcte en atmosphère explosibles 2014/34/EU: Equipment and protective systems intended for use in potentially explosive atmospheres	EN 1127-1: 2019 EN 80079-36: 2016 EN 80079-37: 2016 EN 14986: 2017
Ex-Kennzeichnung: Marquage Ex: Ex Marking:	 II 3/- G Ex h IIB+H ₂ T3 T4 Gc/- II 3/3 G Ex h IIB+H ₂ T3 oder T4 Gc II 2/3 G Ex h IIB+H ₂ T3 ou T4 Gb/Gc II 2/2 G Ex h IIB+H ₂ T3 T4 Gb T3/T4 gem. Typenschild T3/T4 selon la plaque signalétique T3/T4 acc. to the rating plate

Spiez, 31.05.2021



U. Moser (Geschäftsführer/directeur/chief executive officer)

ATEX-Declaration of Conformity

Equipment, components and protection systems for use for their intended purpose in explosion protected zones – **Directive RL 2014/34/EU (ATEX)**

Document number : **TD-000 789**
Product designation: Pipe- / Roof plastic industrial fan CRDV 200-315
Hersteller: COLASIT AG
Faulenbachweg 63
3700 Spiez
Product description Plastic industrial fan for the conveyance of chemically aggressive gases, vapour or correspondingly contaminated air.

The conformity assessment process was conducted in compliance with Directive 2014/34/EU (ATEX). The results are recorded in the confidential **Test Report TD-000 790**. All related documents are kept at the centres named below:





notified body 1258
Eurofins Electric & Electronic Product Testing AG
Luppenstrasse 3
CH – 8320 Fehraltdorf

COLASIT hereby certifies compliance with the basic health and safety requirements for the design and manufacture of equipment and protection systems for use for their intended purpose in explosive atmospheres in compliance with Annex II of the Directive.

The following harmonised standards were applied:

EN 1127-1: Explosive atmospheres – Explosion protection, Part 1, 2019
EN ISO 80079-36: Non-electrical equipment for potentially explosive atmospheres, Part 36, 2016
EN ISO 80079-37: Non-electrical equipment for potentially explosive atmospheres, Part 37, 2016
EN 14986: Design of fans working in potentially explosive atmospheres, 2017

The marking on the appliance must comprise the following information:

-  II 3/-G Ex h IIB+H₂ T3 or T4 Gc/- (conveyed medium Zone 2, site of installation no Zone)
-  II 3/3G Ex h IIB+ H₂ T3 or T4 Gc (conveyed medium Zone 2, site of installation Zone 2)
-  II 2/3G Ex h IIB+ H₂ T3 or T4 Gb/Gc (conveyed medium Zone 1, site of installation Zone 2)
-  II 2/2G Ex h IIB+ H₂ T3 or T4 Gb (conveyed medium Zone 1, site of installation Zone 1)

The associated operating instructions contain important safety instructions and regulations for putting the named equipment into operation in compliance with Directive 2014/34/EU (ATEX).

Changes to the named equipment are prohibited except with the manufacturer's express approval in writing.

If the named equipment is built into a higher level machine, the new risks ensuing from the integration must be assessed by the manufacturer of the new machine.

Spiez, 31.05.2021



Andreas Roth
Authorised representative for documentation



Urs Moser
On behalf of the executive management

Enclosure

Declaration of Conformity No. TD-000 789

Description of appliance or protective system

The pipe-/roof industrial plastic fan CRDV 200-315 with direct drive extract room air or process exhaust air. They are directly driven by electric motors.

Special conditions : If the fans are operated within explosive atmospheres in Zone 1 or 2, they may only be driven by motors for which an appropriate approval (EC type examination certificate) has already been issued.

Temperature Class T4: If the site of installation is Zone 1/2, an explosion proof motor with temperature class T4 must be fitted. If an explosion proof motor with temperature class T3 is used, temperature class T3 shall apply to the entire fan

Ambient temperature: T -20 - 40°C
Maximum temperature of intake medium: 60°C

The minimum flow velocity through the fan has to be minimum 3m/s.

All service and repair work must be carried out by trained service personnel.

Additional information: The radial fans of Equipment Category 3 may only be used to extract gases where the frequency of occurrence of combustible or explosive atmospheres is equivalent to Ex-Zone 2.

Basic safety and health requirements:

Fulfilled by standards.

This certificate may only be copied in full without any changes.

19.3 Further certificates

This operating manual has the following certificates enclosed:

- Datasheet of the fan

If ATEX version additionally:

- ATEX Certification/Inspection report for fan (see 19.2)
- ATEX Certification/Inspection report for electric motor (if this was supplied by COLASIT)

20 Form for the correct assembly ATEX-fans

With ATEX-certified fans, this form must be completed by the fitting team. It serves to verify the proper mounting of the fan and its operating conditions. The completed form must be kept by the safety officer or operating company. It forms the basis of a test voucher quality system which is stipulated by standard EN 14986 (Design of fans for use in explosive atmospheres).

The fitting team shall certify that they have properly executed the following work:

- The fan is mounted on suitable vibration dampers. They are mechanically secured so that the fan cannot slip away or wander.
- For the transitions from the fan to the duct system, elastic sleeves were used to prevent any vibrations from being transferred to the fan.
- The intake and pressure ducting are connected close to the fan.
- With free intake/blow off fans, a protective grating with a mesh width of 10mm is fitted.
- The clearance between the impeller and the casing is min 5mm and max 20mm.
- All rotating parts are protected against unintentional contact.
- The fan is installed so that the motor is supplied with sufficient cooling air (distance to walls, etc.)
- The motor is properly connected in accordance with the manufacturer's instructions (operating manual). The same applies to the PTC resistor, if fitted.
- The motor and the fan is connected to a potential equalisation system.

Test run:

- The minimum air flow through the fan is min 3 m/s and max 30m/s.
- The maximum vibration velocity in operation is not greater than 5.1mm/s measured at the bearings (V-belt drive) or the motor (direct drive).
- The operating temperature is lower than the maximum permitted operating temperature specified on the rating plate.
- The motor current draw is lower than the rated current specified on the rating plate.

If one or more of the works listed above cannot be carried out, please contact the supplier of the manufacturer.

Company name:

Order number:

Fan type:

Name of fitter:

Place and date:

Signature: